

# FURNITURE CATALOGUE

The best steel furniture system

Share the comfortable and creative environment with our Lucky, Kingdom, Okamura and Chitose furniture.



okamura

Chitose



Share the comfortable and creative environment with our LUCKY, KINGDOM, OKAMURA and CHITOSE furniture.



okamura

Chitose

## SPECIALIST AND CREATIVITY

Nowadays steel furniture are coming to replace some of wooden furniture due to its marvelous durability, high flexibility. pleasant looking and easy to maintain.

“Lucky”, “Kingdom”, “Okamura” and “Chitose” steel furniture, then, play a great role to keep these properties so perfectly ; consider by their achievement in many local and international standards and awards. Thus, with our skill, long experience for more than 60 years and great practical designs, “Lucky”, “Kingdom”, “Okamura” and “Chitose” certainly enhance your dignity, personality and comfort.

We have various kinds of furniture for all of your requirement. So, kindly open the coming pages to find how specialist and creative we are in our “Lucky”, “Kingdom”, “Okamura” and “Chitose” the best steel furniture system.

## ผู้เชี่ยวชาญในงานสร้างสรรค์

ปัจจุบันเฟอร์นิเจอร์เหล็กได้เข้ามาแทนที่เฟอร์นิเจอร์ไม้ ด้วยคุณสมบัติที่เหนือกว่าด้านความทนทานเป็นเลิศ ประโยชน์ใช้สอยสูง รูปแบบสวยงามและง่ายต่อการดูแลรักษา

“ลัคกี้” และ “คิงด้อม” ในฐานะเป็นผู้บุกเบิกเฟอร์นิเจอร์เหล็ก ได้เข้ามามีบทบาทสำคัญในการผลิตเฟอร์นิเจอร์เหล็กคุณภาพเยี่ยม ด้วยความชำนาญในการผลิตประสบการณ์อันยาวนานกว่า 60 ปี และการออกแบบซึ่งนอกจากจะเน้นความสวยงามแล้ว ยังมุ่งเน้นประโยชน์ใช้สอยสูงสุด ทำให้เฟอร์นิเจอร์ “ลัคกี้” “คิงด้อม” “โอคามูระ” และ “ชิโตเซะ” ซึ่งเป็นผลิตภัณฑ์ที่ช่วยอำนวยความสะดวก และเสริมสร้างบรรยากาศในการทำงาน จึงได้รับการรับรองมาตรฐานและรางวัลเกียรติยศมากมายจากทั้งภายในประเทศและต่างประเทศ

“ลัคกี้” “คิงด้อม” “โอคามูระ” และ “ชิโตเซะ” มีเฟอร์นิเจอร์หลากหลายชนิดไว้ให้ท่านได้เลือกสรรตามความต้องการ ดังนั้น โปรดพลิกหน้าถัดไปเพื่อพบกับความเชี่ยวชาญ และการสร้างสรรค์ในระบบเฟอร์นิเจอร์เหล็กคุณภาพเยี่ยมของ “ลัคกี้” “คิงด้อม” “โอคามูระ” และ “ชิโตเซะ”



# Siam Steel International Public Company Limited

## Six Decades of Success

- Siam Steel International Public Company Limited, the listed company on the Stock Exchange of Thailand, is part of Siam Steel Group which is Thailand's leading manufacturer of steel products and others. Our businesses dated from 1953.

## Proven Performance

- The stability of the company has been proved with a 2005 Best Performance Award in the consumer product category from the Stock Exchange of Thailand.
- Besides, Forbes has also included Siam Steel International in its Asia's 200 Best Under A Billion list.

## International Quality & Environment Care

- We have received **ISO 9001**, **ISO14001** and **TIS/OHSAS 18001** certificates as well as a **CSR-DIW** (Corporate Social Responsibility).
- We are also permitted to use the **“Thailand Trust Mark”** logo and **“Green Label”**.

## Wide – Ranging Products

- **Steel and Wooden Furniture (movable and built-in) ; “Lucky”, “Kingdom”, “Okamura”, “Chitose” and “Pilot”**

We have over 20,000 designs that fall into the following categories :-

- Cabinets, Lockers and Combine Furniture System
- Desks & Tables
- Chairs
- Partitions
- Others such as furniture for stadiums including bleachers and folding stages.
- **Prefabricated Building ; “LUCKY” Hi-tech Building System**  
We, in collaboration with overseas specialists, have continuously developed prefabricated building under the “LUCKY” Hi-tech Building System with the following categories :-
  - **Permanent Buildings** such as business hotels, convenience stores, showrooms, etc.
  - **Temporary Buildings** such as mobile offices, mobile clinics, kiosks, mobile toilets, etc.
  - **Special Buildings ; specifically designed for each usage** such as telecom shelters, warehouse units, soundproof rooms, etc.

## 6 ทศวรรษแห่งความสำเร็จ

- บริษัท สยามสตีลอินเตอร์เนชั่นแนล จำกัด (มหาชน) เป็นบริษัทที่จดทะเบียนในตลาดหลักทรัพย์แห่งประเทศไทยและเป็นบริษัทในกลุ่มสยามสตีล ซึ่งเป็นกลุ่มผู้ผลิตผลิตภัณฑ์เหล็กและผลิตภัณฑ์อื่น ๆ ในระดับแนวหน้าของไทย บริษัทฯ มีรากฐานทางธุรกิจที่ดำเนินมาอย่างยาวนานนับตั้งแต่ ปี พ.ศ. 2496

## ผลประกอบการที่มั่นคง

- สถานภาพที่มั่นคงของบริษัทฯ ยืนยันได้จากการที่บริษัทฯ ได้รับรางวัลบริษัทที่มีผลการดำเนินงานดีเด่นในปี 2548 ของกลุ่ม Consumer Products จากตลาดหลักทรัพย์แห่งประเทศไทย
- นอกจากนี้ นิตยสารฟอร์บส์ยังจัดอันดับให้บริษัทฯ เป็นหนึ่งใน 200 บริษัทยอดเยี่ยมทั่วโลกในกลุ่มบริษัทที่มียอดขาย 1,000 ล้านดอลลาร์

## คุณภาพระดับมาตรฐานสากลและใส่ใจสิ่งแวดล้อม

- บริษัทฯ คือผู้ผลิตเฟอร์นิเจอร์เหล็กรายแรกในประเทศไทยที่ได้รับการรับรองตามระบบมาตรฐานทั้ง **ISO 9001**, **ISO 14001** และ **TIS/OHSAS 18001** รวมทั้งเครื่องหมาย **ฉลากเขียว (Green Label)**, **มาตรฐานความรับผิดชอบต่อสังคม (CSR-DIW)** และยังได้รับอนุมัติให้ใช้ตราสัญลักษณ์ **“Thailand Trust Mark”** ด้วย

## ผลิตภัณฑ์หลากหลาย

- **เฟอร์นิเจอร์เหล็กและไม้ (ลอยตัว และ Built-in) ; “Lucky”, “Kingdom”, “Okamura”, “Chitose” และ “Pilot”** มีให้เลือกมากกว่า 20,000 ดีไซน์ โดยแบ่งเป็นกลุ่มผลิตภัณฑ์หลักได้ดังนี้ :-
  - กลุ่มตู้ชนิดต่างๆ ล็อคเกอร์ และ Combine Furniture System
  - กลุ่มโต๊ะ
  - กลุ่มเก้าอี้
  - กลุ่มฉากกั้นห้อง
  - กลุ่มตู้ลิ้นชัก
  - กลุ่มชั้นวางของ
  - กลุ่มอื่นๆ เช่น เฟอร์นิเจอร์สำหรับสนามกีฬา รวมทั้ง อัฒจันทร์ (Bleachers) และเวทีพับ (Folding Stages) เป็นต้น
- **อาคารสำเร็จรูปอุปโภคบริโภค ; “LUCKY” Hi-tech Building System**  
บริษัทฯ ได้ร่วมมือกับผู้เชี่ยวชาญต่างประเทศในการพัฒนาอย่างต่อเนื่อง ซึ่งแบ่งออกเป็นกลุ่มใหญ่ๆ ได้ ดังนี้ :-
  - **อาคารแบบถาวร** เช่น business hotels, convenience stores, showrooms เป็นต้น
  - **อาคารแบบชั่วคราว** เช่น mobile offices, mobile clinics, kiosks, mobile toilets เป็นต้น
  - **อาคารแบบพิเศษเฉพาะงาน** เช่น telecom shelters, warehouse units, soundproof rooms เป็นต้น



# OUTLINE OF SIAM STEEL GROUP

## Siam Steel Group's first business operation began in 1953

With 6 decades of experience in manufacturing and distribution, currently Siam Steel Group expands its business into a wide range of industries to supply its products for domestic and worldwide markets.

Furthermore, Siam Steel Group has operated under the international joint-venture among many of the world's leading companies, such as Panasonic Group, Nippon Steel Group, Mitsubishi Group, Mitsui Group, Toyota Group, Honda Group, Okamura Group, Okaya Group, etc.

At present, Siam Steel Group stands as one of the leader of Thai industry with total registered capital of Baht 15,000 million (US\$ 483 million), total asset of Baht 51,266 million (US\$ 1,650 million) and total annual turnover of Baht 70,392 million (US\$ 2,266 million), (as of 2011). Among 27 companies, 14 companies are international joint-venture basis, involving in 5 product categories ;

<p><b>FURNITURE GROUP</b></p> <ul style="list-style-type: none"> <li>• Attained ISO 9001 Certificate</li> <li>• Attained ISO 14001 Certificate</li> <li>• Attained TIS/OHSAS 18001 Certificate</li> <li>• Attained CSR-DIW Certificate <i>(Corporate Social Responsibility)</i></li> <li>• Approved to use the “Green Label”</li> <li>• Approved to use the “Thailand Trust Mark”</li> </ul>	<p>Steel and Wooden Furniture (movable and built-in)</p> <ul style="list-style-type: none"> <li>• Cabinets, Lockers &amp; Combine Furniture System</li> <li>• Desks &amp; Tables                      • Chairs</li> <li>• Safes                                      • Partitions</li> <li>• Shelf System</li> <li>• Others such as Bleachers and Folding Stages, etc.</li> </ul>
<p><b>INDUSTRIAL GOODS GROUP</b></p> <ul style="list-style-type: none"> <li>• Attained ISO 9001 Certificate</li> <li>• Attained ISO 14001 Certificate</li> <li>• Attained ISO 18001 Certificate</li> <li>• Attained CSR-DIW Certificate <i>(Corporate Social Responsibility)</i></li> </ul>	<ul style="list-style-type: none"> <li>• Pre-fabricated buildings</li> <li>• Decorative Laminates</li> <li>• Honeycomb core, paper pallet, paper cushion</li> </ul>
<p><b>CONSTRUCTION MATERIALS GROUP</b></p> <ul style="list-style-type: none"> <li>• Attained ISO 9001 Certificate</li> <li>• Attained ISO 14001 Certificate</li> <li>• Attained ISO/TIS 16949 Certificate</li> <li>• Attained ISO 18001 Certificate</li> </ul>	<ul style="list-style-type: none"> <li>• Steel service center and elementary steel parts for various industries</li> <li>• Conduit pipe, fitting and accessories, steel pipe</li> <li>• Civil Engineering Products and steel parts for various industries</li> <li>• Flood Protection Products and other related products</li> </ul>
<p><b>VEHICLE GROUP</b></p> <ul style="list-style-type: none"> <li>• Attained ISO 9001 Certificate</li> <li>• Attained ISO 14001 Certificate</li> <li>• Attained ISO/TIS 16949 Certificate</li> <li>• Attained TIS/OHSAS 18001 Certificate</li> </ul>	<ul style="list-style-type: none"> <li>• Parts &amp; components for vehicle</li> </ul>
<p><b>SERVICE GROUP</b></p>	<ul style="list-style-type: none"> <li>• Supply and rental of prefabricated buildings and mobile toilets</li> <li>• Supply various kind of products of affiliated companies and other general goods</li> </ul>



## กลุ่มสยามสตีล ได้เริ่มก่อตั้งเมื่อปี พ.ศ. 2496

จากประสบการณ์กว่า 6 ทศวรรษ ในการเป็นผู้ผลิต และผู้จัดจำหน่ายผลิตภัณฑ์ต่าง ๆ ปัจจุบัน กลุ่มสยามสตีลได้ขยายธุรกิจไปยังอุตสาหกรรมที่หลากหลาย เพื่อตอบสนองความต้องการของตลาดทั้งในประเทศ และส่งออกไปจำหน่ายยังประเทศต่าง ๆ ทั่วโลก

ยิ่งไปกว่านั้น กลุ่มสยามสตีลยังได้ดำเนินงานโดยการร่วมทุนระหว่างประเทศกับบริษัทชั้นนำต่าง ๆ ของโลก เช่น กลุ่ม Panasonic กลุ่ม Nippon Steel กลุ่ม Mitsui กลุ่ม Mitsubishi กลุ่ม Toyota กลุ่ม Honda กลุ่ม Okamura และกลุ่ม Okaya เป็นต้น

ปัจจุบัน กลุ่มสยามสตีลเป็นหนึ่งในบริษัทชั้นนำในวงการอุตสาหกรรมของไทย มีทุนจดทะเบียนรวม 15,000 ล้านบาท สินทรัพย์รวม 51,266 ล้านบาท และยอดขายรวม 70,392 ล้านบาท (ณ ปี พ.ศ. 2554) มีบริษัทในกลุ่มทั้งหมด 27 บริษัท เป็นบริษัทร่วมทุนระหว่างประเทศ 14 บริษัท ดำเนินธุรกิจใน 5 กลุ่มผลิตภัณฑ์หลัก ได้แก่

<p><b>กลุ่มผลิตภัณฑ์เฟอร์นิเจอร์</b></p> <ul style="list-style-type: none"> <li>• ได้รับใบรับรอง ISO 9001</li> <li>• ได้รับใบรับรอง ISO 14001</li> <li>• ได้รับใบรับรอง TIS/OHSAS 18001</li> <li>• ได้รับใบรับรอง CSR-DIW (ความรับผิดชอบต่อสังคม) ของผู้ประกอบการอุตสาหกรรมต่อสังคม)</li> <li>• ได้รับเครื่องหมาย “ฉลากเขียว”</li> <li>• ได้รับเครื่องหมาย “Thailand Trust Mark”</li> </ul>	<p>เฟอร์นิเจอร์เหล็กและไม้ (ลอยตัว &amp; Built-in)</p> <ul style="list-style-type: none"> <li>• กลุ่มตู้ และ Combine Furniture System</li> <li>• กลุ่มโต๊ะ</li> <li>• กลุ่มเก้าอี้</li> <li>• กลุ่มตู้เซฟ</li> <li>• ฉากกันห้อง ล็อกเกอร์</li> <li>• กลุ่มชั้นวางของ และชั้นอุตสาหกรรม</li> <li>• กลุ่มอื่นๆ เช่น อัฒจันทร์ และเวทีพับ เป็นต้น</li> </ul>
<p><b>กลุ่มสินค้าอุตสาหกรรมทั่วไป</b></p> <ul style="list-style-type: none"> <li>• ได้รับใบรับรอง ISO 9001</li> <li>• ได้รับใบรับรอง ISO 14001</li> <li>• ได้รับใบรับรอง TIS/OHSAS 18001</li> <li>• ได้รับใบรับรอง CSR-DIW (ความรับผิดชอบต่อสังคม) ของผู้ประกอบการอุตสาหกรรมต่อสังคม)</li> </ul>	<ul style="list-style-type: none"> <li>• อาคารสำเร็จรูปอบเนกประสงค์</li> <li>• Decorative Laminates</li> <li>• Honeycomb cores, paper pallets, paper cushions</li> </ul>
<p><b>กลุ่มชิ้นส่วนวัสดุก่อสร้าง</b></p> <ul style="list-style-type: none"> <li>• ได้รับใบรับรอง ISO 9001</li> <li>• ได้รับใบรับรอง ISO 14001</li> <li>• ได้รับใบรับรอง ISO/TIS 16949</li> <li>• ได้รับใบรับรอง TIS/OHSAS 18001</li> </ul>	<ul style="list-style-type: none"> <li>• ศูนย์บริการเหล็ก และชิ้นส่วนเหล็กเพื่ออุตสาหกรรมต่างๆ</li> <li>• ท่อร้อยสายไฟ และอุปกรณ์ต่อเนื่อง ท่อเหล็ก</li> <li>• ผลิตภัณฑ์ที่เกี่ยวข้องกับงานก่อสร้าง (Civil Engineering Products)</li> <li>• ผนังกันน้ำและผลิตภัณฑ์ที่เกี่ยวข้อง</li> </ul>
<p><b>กลุ่มยานยนต์</b></p> <ul style="list-style-type: none"> <li>• ได้รับใบรับรอง ISO 9001</li> <li>• ได้รับใบรับรอง ISO 14001</li> <li>• ได้รับใบรับรอง ISO/TIS 16949</li> <li>• ได้รับใบรับรอง TIS/OHSAS 18001</li> </ul>	<ul style="list-style-type: none"> <li>• ชิ้นส่วนและส่วนประกอบยานยนต์</li> </ul>
<p><b>กลุ่มบริการ</b></p>	<ul style="list-style-type: none"> <li>• จำหน่ายและให้เช่าอาคารสำเร็จรูป ห้องน้ำเคลื่อนที่ และผลิตภัณฑ์ที่เกี่ยวข้อง</li> <li>• จำหน่ายผลิตภัณฑ์ต่างๆ จากบริษัทในเครือ และผลิตภัณฑ์ทั่วไป</li> </ul>



# CONTENTS

---

08



## FILING & STORAGE

- 09 THE BIG BAND
- 14 COMBINE FURNITURE SYSTEM 1
- 18 COMBINE FURNITURE SYSTEM 2
- 23 FILING CABINETS
- 30 COMPACTUS
- 34 LOCKER

38



## DESK & TABLE

- 39 EXECUTIVE DESK
- 41 DESK
- 49 OKAMURA
- 57 FOLDING TABLES
- 61 CONFERENCE TABLES
- 64 TABLES

67



## SEATING & LOUNGE

- 68 EXECUTIVE CHAIRS
- 70 TASK CHAIRS
- 78 MULTI-TASK CHAIRS
- 101 MATERIAL & COLORS

102



## PARTITION

- 103 PARTITION
- 112 MATERIAL & COLORS



**SAFE**

- 115 MODERN COMPACT FIRE RESISTANT SAFES
- 116 COMPACT FIRE RESISTANT SAFES
- 117 DIGNIFIED FIRE RESISTANT SAFES,  
2 - DOOR TYPE
- 118 DAY - NIGHT FIRE RESISTANT DEPOSIT SAFES
- 119 BURGLARY RESISTANT DOORS
- 120 ELECTRONIC SAFES



**SHELVES**

- 127 INDUSTRIAL SHELVES
- 128 OA SHELVES



**OTHERS**

- 134 MODERN HOME AND HOME OFFICE
- 136 SPECIAL PRODUCT AND  
FURNITURE ACCESSORIES
- 139 INDUSTRIAL EQUIPMENTS



**141 PROJECT REFERENCES**



# FILING & STORAGE

"Lucky" Filing Cabinets are designed and manufactured with a focus on strength and durability. Drawers are equipped with extra strong slides for bearing capability of full loading documents. They are in many designs for various requirements to store several kinds of documents such as A4 & legal size paper, overlay paper, stock cards, etc.





## THE BIG BAND

### FILING & STORAGE

ระบบตู้เอกสารได้รับการออกแบบมาให้เหมาะสมกับการใช้งาน ในการจัดเก็บเอกสารและแฟ้มขนาดใหญ่และขนาดมาตรฐานต่างๆ มีแบบให้เลือกมากมายตามวัตถุประสงค์การใช้งาน โดยมีทั้งแบบบานประตูแบบบานเลื่อนและบานเปิด รวมทั้งแบบไม่มีบานประตู (แบบเปิดโล่ง) แต่ละรุ่นสามารถใช้ร่วมกันเป็นชุดที่สวยงาม หรือแยกใช้แต่ละตู้โดยอิสระ ทุกรุ่นมีขนาดความกว้างและความลึกเป็นมาตรฐานเดียวกัน สามารถวางเรียงต่อหรือซ้อนกันได้สวยงามตั้งแต่พื้นจรดเพดาน เพื่อประหยัดเนื้อที่ที่ใช้สอย รวมทั้งยังมีแผ่นหน้าไม้ที่เข้าชุดกับโต๊ะทำงานให้เลือกวางบนตู้ เพื่อเพิ่มความสวยงามอีกด้วย

“Lucky” Cabinet System is designed to suit for applications in filing various standard sizes and types of documents and papers. There are several models for selection according to the function such as the sliding door and swing door cabinet including open shelves (without door). Each model could be beautifully set together or it could be stood alone unit. Each model is designed in the same standard size, it is able to combine or add on beautifully from floor to ceiling, thus, help saving the space. Cabinet tops with the same design of work tops are also available for option to place on the cabinet for more elegance.





# THE BIG BAND

## Open shelving cabinets



**O - 975**  
open shelving cabinet  
with 1 shelf  
900W x 400D x 750H mm.



**O - 9115**  
open shelving cabinet  
with 1 shelf  
900W x 400D x 1150H mm.



**O - 9155**  
open shelving cabinet  
with 2 shelves  
900W x 400D x 1550H mm.



**O - 9195**  
open shelving cabinet  
with 3 shelves  
900W x 400D x 1950H mm.

## Double swing door cabinets



**D - 975**  
double swing door cabinet  
with 1 shelf  
900W x 400D x 750H mm.



**D - 9115**  
double swing door cabinet  
with 1 shelf  
900W x 400D x 1150H mm.



**D - 9155**  
double swing door cabinet  
with 2 shelves  
900W x 400D x 1550H mm.



**D - 9195**  
double swing door cabinet  
with 3 shelves  
900W x 400D x 1950H mm.

**D - 930**  
double swing door cabinet  
900W x 400D x 300H mm.

## Sliding steel door cabinets



**S - 975**  
sliding steel door cabinet  
with 1 shelf  
900W x 400D x 750H mm.



**S - 9115**  
sliding steel door cabinet  
with 1 shelf  
900W x 400D x 1150H mm.



**NEW IVORY (#280)**  
BODY : STANDARD COLOR FOR CABINET SYSTEM "THE BIG BAND"  
COLOR MAY NOT BE EXACTLY SHOWN

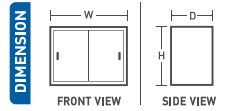

## Open shelving & Double swing door cabinets



**OD - 9155**  
open shelving & double swing door cabinet with 2 shelves  
900W x 400D x 1550H mm.



**OD - 9195**  
open shelving & double swing door cabinet with 3 shelves  
900W x 400D x 1950H mm.

## Open shelving & Sliding steel door cabinets



**OS - 9155**  
open shelving & sliding steel door cabinet with 2 shelves  
900W x 400D x 1550H mm.

## Double swing doors & Open shelving cabinets



**DO - 9115**  
double swing door & open shelving cabinet with 1 shelf  
900W x 400D x 1150H mm.



**DO - 9155**  
double swing door & open shelving cabinet with 2 shelves  
900W x 400D x 1550H mm.



**DO - 9195**  
double swing door & open shelving cabinet with 3 shelves  
900W x 400D x 1950H mm.

## Double swing door & Double swing door cabinets



**DD - 9155**  
double swing door & double swing door cabinet with 2 shelves  
900W x 400D x 1550H mm.



**DD - 9195**  
double swing door & double swing door cabinet with 3 shelves  
900W x 400D x 1950H mm.

## Double swing door & Sliding steel door cabinets



**DS - 9155**  
double swing door & sliding steel door cabinet with 2 shelves  
900W x 400D x 1550H mm.



**NEW IVORY (#280)**  
BODY : STANDARD COLOR FOR CABINET SYSTEM "THE BIG BAND"  
COLOR MAY NOT BE EXACTLY SHOWN



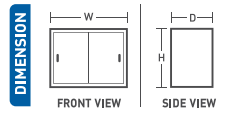

## Sliding steel door & Open shelving cabinets



**SO - 9115**  
sliding steel door & open shelving cabinet with 1 shelf  
900W x 400D x 1150H mm.



**SO - 9155**  
sliding steel door & open shelving cabinet with 2 shelves  
900W x 400D x 1550H mm.



**SO - 9195**  
sliding steel door & open shelving cabinet with 3 shelves  
900W x 400D x 1950H mm.

## Sliding steel door & Double swing door cabinets



**SD - 9155**  
sliding steel door & double swing door cabinet with 2 shelves  
900W x 400D x 1550H mm.



**SD - 9195**  
sliding steel door & double swing door cabinet with 3 shelves  
900W x 400D x 1950H mm.



**SS - 9155**  
sliding steel door & sliding steel door with 2 shelves  
900W x 400D x 1550H mm.

## Sliding steel door & Sliding steel door cabinets

## Adjustable top beam



**NEW IVORY (#280)**  
\*\*COLOR MAY NOT BE EXACTLY SHOWN

**BBA - 925T**  
900W x 400D x 165 - 250H mm.

**BBA - 911T**  
900W x 400D x 65 - 100H mm.

**BBA - 918T**  
900W x 400D x 110 - 180H mm.

## Top



**T - 921**  
900W x 410D x 20H mm.



**H - 915**  
860W x 345D x 18H mm.

**TOP : POSTFORM MELAMINE LAMINATE**  
COLOR : No. PF 7016 IM  
COLOR MAY NOT BE EXACTLY SHOWN

**NEW IVORY (#280)**  
BODY : STANDARD COLOR FOR CABINET SYSTEM "THE BIG BAND"  
COLOR MAY NOT BE EXACTLY SHOWN

# Feature & Benefit



Handle-C-Type



Open shelf storage



Hinged door system



Adjustable shelf



# COMBINE FURNITURE SYSTEM 1

## FILING & STORAGE

ตู้เก็บเอกสาร "ลัคกี้" คอมไบน์ ซีรีส์ 1 ทางเลือกสำหรับสำนักงานสมัยใหม่ เพื่อระบบจัดเก็บเอกสารที่เป็นระเบียบสวยงามด้วยเฟอร์นิเจอร์ที่ได้รับการออกแบบอย่างพิถีพิถัน มีให้เลือกมากมายหลายแบบตามความต้องการใช้งาน อาทิ ตู้เก็บเอกสารระบบบานเปิดและบานเลื่อน ชั้นเก็บเอกสาร ตู้ระบบลิ้นชักเพื่อเก็บแฟ้มแขวน เป็นต้น ซึ่งทุกรุ่นมีขนาดความกว้างและความลึกเป็นมาตรฐานเดียวกัน จึงสามารถจัดวางเรียงต่อหรือซ้อนกันได้อย่างเป็นระเบียบสวยงามตั้งแต่จรดเพดานห้องตามลักษณะพื้นที่และการใช้งาน ซึ่งนอกจากจะประหยัดเนื้อที่ที่ใช้สอยแล้วยังช่วยเพิ่มความเป็นระเบียบและความสวยงามทันสมัยให้แก่สำนักงานอีกด้วย

"Lucky" Combine Furniture System: Series 1, an alternative for modern office for perfect filing system. The whole system is carefully designed with many models according to the application such as swinging door cabinet and sliding door cabinet, shelf, drawer cabinet for hanging file, etc. Each model is designed in the same standard size, it is able to combine or add on beautifully from floor to ceiling as its function, thus, not only help saving the space, but also making office to be modern and more



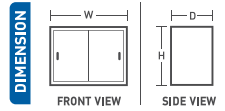

# COMBINE FURNITURE SYSTEM 1

## Open shelving cabinets



**LCH - 975**  
open shelving cabinet with 1 shelf  
900W x 450D x 750H mm.



**LCH - 9110**  
open shelving cabinet with 2 shelves  
900W x 450D x 1100H mm.

## Double swing door cabinets



**LCD - 975**  
double swing door cabinet with 1 shelf  
900W x 450D x 750H mm.



**LCD - 9110**  
double swing door cabinet with 2 shelves  
900W x 450D x 1100H mm.



**LCD - 9185**  
double swing door cabinet  
with 3 shelves  
900W x 450D x 1850H mm.

## Sliding glass door cabinets



**LCG - 975**  
sliding glass door cabinet  
with 1 shelf  
900W x 450D x 750H mm.



**LCG - 9110**  
sliding glass door cabinet  
with 2 shelves  
900W x 450D x 1100H mm.



**LCG - 9185**  
sliding glass door cabinet  
with 3 shelves  
900W x 450D x 1850H mm.

**LCG - 1275**  
sliding glass door cabinet  
with 1 shelf  
1200W x 450D x 750H mm.

**LCG - 12110**  
sliding glass door cabinet  
with 2 shelves  
1200W x 450D x 1100H mm.

**LCG - 1575**  
sliding glass door cabinet  
with 1 shelf  
1500W x 450D x 750H mm.

**LCG - 15110**  
sliding glass door cabinet  
with 2 shelves  
1500W x 450D x 1100H mm.

 BODY COLOR : CREAM (#180)  
COLOR MAY NOT BE EXACTLY SHOWN





## Sliding steel door cabinets



**LCS - 975**  
sliding steel door cabinet  
with 1 shelf  
900W x 450D x 750H mm.



**LCS - 9110**  
sliding steel door cabinet  
with 2 shelves  
900W x 450D x 1100H mm.



**LCS - 9185**  
sliding glass door cabinet  
with 3 shelves  
900W x 450D x 1850H mm.

**LCS - 1275**  
sliding steel door cabinet  
with 1 shelf  
1200W x 450D x 750H mm.

**LCS - 12110**  
sliding steel door cabinet  
with 2 shelves  
1200W x 450D x 1100H mm.

**LCS - 1575**  
sliding steel door cabinet  
with 1 shelf  
1500W x 450D x 750H mm.

**LCS - 15110**  
sliding steel door cabinet  
with 2 shelves  
1500W x 450D x 1100H mm.

## Drawer filing cabinets



**LCF - 975**  
drawer filing cabinet  
with 2 drawers  
900W x 450D x 750H mm.



**LCF - 975 - 2**  
drawer filing cabinet  
with 2 drawers & 1 swing door  
900W x 450D x 750H mm.



**LCF - 9110**  
drawer filing cabinet  
with 3 drawers  
900W x 450D x 1100H mm.



**LCF - 9110 - 3**  
drawer filing cabinet  
with 3 drawers & 1 swing door  
900W x 450D x 1100H mm.

### Base



**LCA - 910 B** 900w x 450D x 100H mm.  
**LCA - 1210 B** 1200w x 450D x 100H mm.  
**LCA - 1510 B** 1500w x 450D x 100H mm.

### Adjustable top beam



**LCA - 911 T** 900w x 450D x 65 - 100H mm.  
**LCA - 1211 T** 1200w x 450D x 65 - 100H mm.  
**LCA - 1511 T** 1500w x 450D x 65 - 100H mm.

### Shelves



**LCA - 925 S** 880w x 380D x 25H mm.  
**LCA - 925 D** 880w x 420D x 25H mm.  
**LCA - 1225 S** 1180w x 380D x 25H mm.  
**LCA - 1525 S** 1480w x 380D x 25H mm.



**LCA - 918 T** 900w x 450D x 110 - 180H mm.  
**LCA - 1218 T** 1200w x 450D x 110 - 180H mm.  
**LCA - 1518 T** 1500w x 450D x 110 - 180H mm.



**LCA - 925 T** 900w x 450D x 165 - 250H mm.  
**LCA - 1225 T** 1200w x 450D x 165 - 250H mm.  
**LCA - 1525 T** 1500w x 450D x 165 - 250H mm.



BODY COLOR : CREAM (#180)  
COLOR MAY NOT BE EXACTLY SHOWN

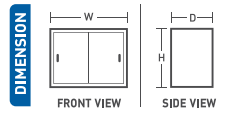

## Cabinet top



- T - 925 900w x 450D x 25H mm.
- T - 1225 1200w x 450D x 25H mm.
- T - 1525 1500w x 450D x 25H mm.



TOP COLOR : POSTFORM MELAMINE LAMINATE  
No. PF 6149 IM  
\*\*COLOR MAY NOT BE EXACTLY SHOWN



- T - 920 900w x 450D x 20H mm.
- T - 1220 1200w x 450D x 20H mm.
- T - 1520 1500w x 450D x 20H mm.



TOP COLOR : POSTFORM MELAMINE LAMINATE  
No. PF 6149 IM  
\*\*COLOR MAY NOT BE EXACTLY SHOWN

## Feature & Benefit



Open shelf storage



Sliding glazed door



Handle + Lock system



Adjustable shelf



## COMBINE FURNITURE SYSTEM 2

### FILING & STORAGE

ตู้เก็บเอกสาร “ลัคกี้” คอมไบน์ ซีรีส์ 2 ดีไซน์ญี่ปุ่น ประกอบด้วยตู้แบบต่างๆ เช่น ตู้เอกสารแบบบานเปิดและบานเลื่อน ชั้นเก็บเอกสาร ตู้ลิ้นชัก รวมทั้งตู้อเนกประสงค์ที่มีราวแขวนเสื้อผ้าและชั้นเก็บของใช้ส่วนตัว สามารถจัดวางร่วมกับเฟอร์นิเจอร์สำนักงานชิ้นอื่นๆ ได้อย่างกลมกลืนสวยงาม เฟอร์นิเจอร์ทุกรุ่นมีขนาดมาตรฐานเดียวกัน จึงสามารถจัดวางเรียงต่อหรือซ้อนกันได้อย่างเป็นระเบียบ ยิ่งไปกว่านั้นยังสามารถจัดวางเรียงซ้อนจรดเพดานได้ด้วยแผ่นปรับเสริมความสูง และยึดติดกันอย่างแข็งแรงจนมองเหมือนเป็นชั้นเดียวกัน ง่ายต่อการปรับเปลี่ยน อีกทั้งยังปลอดภัยเมื่อใช้在高楼ซึ่งเสี่ยงต่อความเสียหายจากแผ่นดินไหว สามารถตอบสนองความต้องการของสำนักงานทันสมัยทั้งในปัจจุบันและอนาคต

“Lucky” Combine Furniture System : Series 2, Japanese style, consists of various cabinets such as swinging door cabinet and sliding door cabinet, shelf, drawer cabinet including multi-purpose cabinet with clothes hanger and shelf for keeping personal belongings. They can be set together with any other office furniture beautifully and because of the same standard size, it can also be combined or add on perfectly. Moreover, it is able to add on up to the ceiling with the adjustable top beam and strongly join together to look like the same unit. Easy adjustment and safe for high-rise building which is risk of earthquake, thus it could respond to the needs of modern office both at present and in the future.



# COMBINE FURNITURE SYSTEM 2

## Open shelving cabinets



**OCH - 970**  
open shelving cabinet with 1 shelf  
900W x 450D x 700H mm.



**OCH - 9100**  
open shelving cabinet with 2 shelves  
900W x 450D x 1000H mm.



**OCH - 9120**  
open shelving cabinet with 2 shelves  
900W x 450D x 1200H mm.

**OCH - 9110**  
open shelving cabinet with 2 shelves  
900W x 450D x 1100H mm.

## Double swing door cabinets



**OCD - 930**  
double swing door cabinet  
900W x 450D x 300H mm.



**OCD - 970**  
double swing door cabinet  
with 1 shelf  
900W x 450D x 700H mm.



**OCD - 9100**  
double swing door cabinet  
with 2 shelves  
900W x 450D x 1000H mm.



**OCD - 9120**  
double swing door cabinet  
with 2 shelves  
900W x 450D x 1200H mm.

**OCD - 940**  
double swing door cabinet  
900W x 450D x 400H mm.

**OCD - 9110**  
double swing door cabinet  
with 2 shelves  
900W x 450D x 1100H mm.

## Wardrobes



**OCD - 9180**  
wardrobe with 4 shelves  
900W x 450D x 1800H mm.



**OCW - 9180**  
wardrobe  
900W x 450D x 1800H mm.

## Drawer filing cabinets



**OCF - 970 D**  
drawer filing cabinet  
with 2 drawers  
900W x 450D x 700H mm.



**OCF - 9110 D**  
drawer filing cabinet  
with 3 drawers  
900W x 450D x 1100H mm.



BODY COLOR : NEW IVORY (#280)  
COLOR MAY NOT BE EXACTLY SHOWN



## Sliding glass door cabinets



**OCG - 970**  
open shelving cabinet  
with 1 shelf  
900W x 450D x 700H mm.



**OCG - 9100**  
sliding glass door cabinet  
with 2 shelves  
900W x 450D x 1000H mm.



**OCG - 9110**  
sliding glass door cabinet  
with 2 shelves  
900W x 450D x 1100H mm.



**OCG - 9120**  
sliding glass door cabinet  
with 2 shelves  
900W x 450D x 1200H mm.

## Sliding steel door cabinets



**OCS - 970**  
sliding steel door cabinet  
with 1 shelf  
900W x 450D x 700H mm.



**OCS - 9100**  
sliding steel door cabinet  
with 2 shelves  
900W x 450D x 1000H mm.



**OCS - 9110**  
sliding steel door cabinet  
with 2 shelves  
900W x 450D x 1100H mm.



**OCS - 9120**  
sliding steel door cabinet  
with 2 shelves  
900W x 450D x 1200H mm.

## Base unit



**OCA - 910B**  
900W x 450D x 100H mm.



**OCA - 911T**  
900W x 450D x 65 - 100H mm.

## Shelves



**OCA - 915S**  
893W x 378D x 15H mm.



**OCA - 918T**  
900W x 450D x 110 - 180H mm.



**OCA - 925T**  
900W x 450D x 165 - 250H mm.

**BODY COLOR : NEW IVORY (#280)**  
COLOR MAY NOT BE EXACTLY SHOWN

## Slim line set (Side 2 side cabinets system)



ระบบการจัดเก็บเอกสารที่ประหยัดพื้นที่ด้วยการ  
จัดเก็บเอกสารแบบวางเลื่อนแนวตั้ง 2 ชั้น

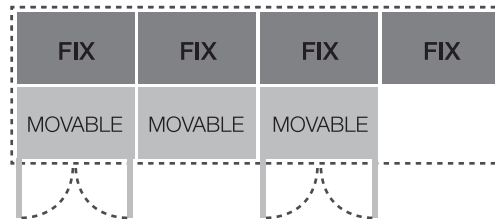

### Example

สินค้าที่นำมาใช้ร่วมกับราว SLIM LINE SET ต้องเป็นสินค้าในหมวดของ COMBINE FURNITURE SYSTEM 2 เท่านั้น  
ความสูงของตู้ที่เลือกใช้ต้องมีความสูงรวมไม่เกินความสูงของ UNIT (H)

สามารถเลือกตำแหน่งการจัดชั้นวางได้ตามความต้องการ

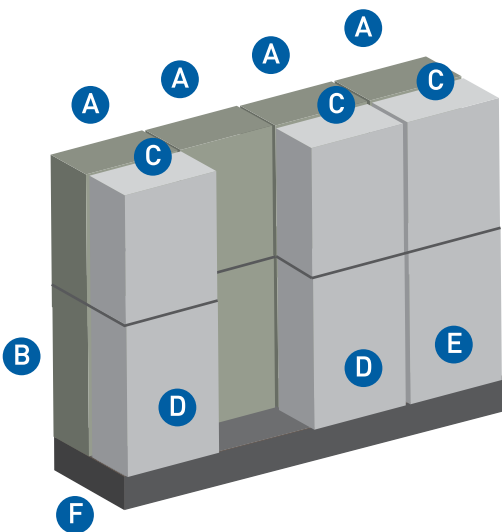







- A** OCH - 970  
900W x 450D x 700H mm.
- B** OCH - 9100  
900W x 450D x 1000H mm.  
900W x 450D x 1100H mm.
- C** OCG - 970  
900W x 450D x 700H mm.
- D** OCF - 9110 D  
900W x 450D x 1100H mm.
- E** OCD - 9110  
900W x 450D x 1000H mm.  
900W x 450D x 1100H mm.

F	BASE SIDE (W x D x H) mm.	UNIT FIX / MOVABLE	UNIT (H) mm.	CODE
	3660 x 935 x 110	4 UNIT / 3 UNIT 	1800	N 994 BE

BODY COLOR : WARM BLACK (#270)  
COLOR MAY NOT BE EXACTLY SHOWN

## Base unit for slim line set

BASE SIZE (W x D x H) mm.	UNIT FIX / MOVABLE	HEIGHT (H) mm.	MODEL
915 x 935 x 110	 ADD 1 UNIT / 1 UNIT	1100	N 991 BB
		1200	N 991 BC
		1400	N 991 BD
		1800	N 991 BE
		2100	N 991 BF
1830 x 935 x 110	 2 UNITS / 1 UNIT	1100	N 992 BB
		1200	N 992 BC
		1400	N 992 BD
		1800	N 992 BE
		2100	N 992 BF
2745 x 935 x 110	 3 UNITS / 2 UNITS	1100	N 993 BB
		1200	N 993 BC
		1400	N 993 BD
		1800	N 993 BE
		2100	N 993 BF
3660 x 935 x 110	 4 UNITS / 3 UNITS	1100	N 994 BB
		1200	N 994 BC
		1400	N 994 BD
		1800	N 994 BE
		2100	N 994 BF
4575 x 935 x 110	 5 UNITS / 4 UNITS	1100	N 995 BB
		1200	N 995 BC
		1400	N 995 BD
		1800	N 995 BE
		2100	N 995 BF
5490 x 935 x 110	 6 UNITS / 5 UNITS	1100	N 996 BB
		1200	N 996 BC
		1400	N 996 BD
		1800	N 996 BE
		2100	N 996 BF
6405 x 935 x 110	 7 UNITS / 6 UNITS	1100	N 997 BB
		1200	N 997 BC
		1400	N 997 BD
		1800	N 997 BE
		2100	N 997 BF

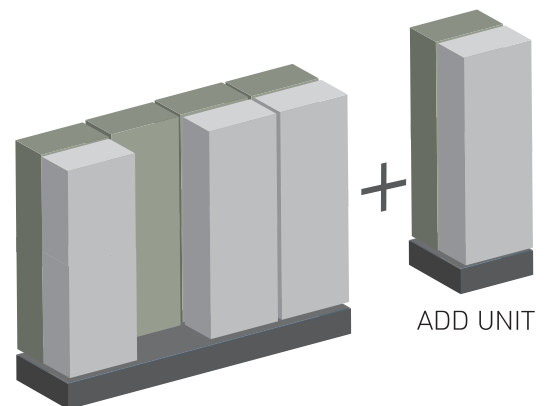
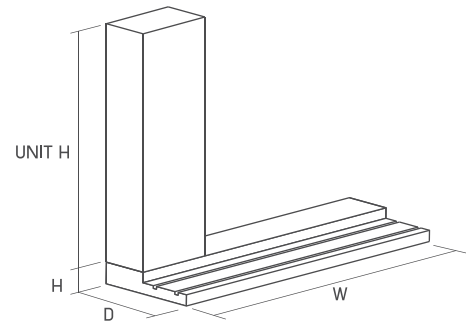
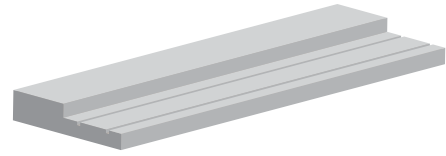



FILING & STORAGE

# FILING CABINETS

## FILING & STORAGE

ตู้เก็บเอกสาร “ลัคกี้” เฟอร์นิเจอร์คุณภาพมาตรฐาน ออกแบบ และผลิตโดยเน้นความแข็งแรงทนทาน ลื่นชักเลื่อน เก็บได้อย่างนิ่มนวล มีรางลื่นชักแข็งแรงเป็นพิเศษ สามารถรับน้ำหนักเอกสารได้เต็มตู้ มีหลายรูปแบบหลายขนาดให้เลือกสรร ใช้สำหรับเอกสารประเภทต่างๆ อาทิ กระดาษขนาด A4 และขนาด legal กระดาษพิมพ์เขียวและกระดาษการ์ดสำหรับทำสต็อก เป็นต้น

“Lucky” Filing Cabinets are designed and manufactured with a focus on strength and durability. Drawers are equipped with extra strong slides for bearing capability of full loading documents. There are many designs for various requirements to store several kinds of documents such as A4 & legal size paper, overlay paper, stock cards, etc.





## Sliding steel doors



**DO - 213**  
880W x 406D x 572H mm.

**DO - 214**  
1185W x 406D x 572H mm.

**DO - 215**  
1490W x 406D x 572H mm.

**DO - 216**  
1795W x 406D x 572H mm.



**DO - 313**  
880W x 406D x 880H mm.

**DO - 314**  
1185W x 406D x 880H mm.

**DO - 315**  
1490W x 406D x 880H mm.

**DO - 316**  
1795W x 406D x 880H mm.

## Sliding glass doors



**DG - 223**  
880W x 406D x 572H mm.

**DG - 224**  
1185W x 406D x 572H mm.



**DG - 225**  
1490W x 406D x 572H mm.

**DG - 226**  
1795W x 406D x 572H mm.



**DG - 323**  
880W x 406D x 880H mm.

**DG - 324**  
1185W x 406D x 880H mm.



**DG - 325**  
1490W x 406D x 880H mm.

**DG - 326**  
1795W x 406D x 880H mm.



**BODY COLOR : CREAM (#180)**  
COLOR MAY NOT BE EXACTLY SHOWN



**BODY COLOR : GRAY (#140)**  
**DOOR, SHELVE COLOR : LIGHT GRAY (#150)**  
COLOR MAY NOT BE EXACTLY SHOWN  
(OPTIONAL)

## Shelves



SIZE			MODEL
W	D	H	
855			S - 300
1163	334	21	S - 400
1470			S - 500

## Top



SIZE			MODEL
W	D	H	
880			T - 3F
1185	406	28	T - 4F
1490			T - 5F
1795			T - 6F

## Base



SIZE			MODEL
W	D	H	
880	406	76	S - 013
1185			S - 014
1490			S - 015
1795		152	S - 016
880			S - 023
1185			S - 024
1490	S - 025		
1795	S - 026		



**CREAM (#180)**  
BODY : STANDARD COLOR FOR SHELF



**NO. PP 6149**  
TOP : HIGH PRESSURE LAMINATE



**FLAT BLACK (#130)**  
BASE : STANDARD COLOR FOR BASE



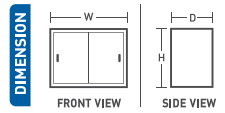

# FILING CABINETS

## Vertical filing cabinets with interlock system

FILING & STORAGE



**DD - 994 C**  
4 drawer filing cabinet  
464W x 616D x 1320H mm.

**DD - 993 C**  
3 drawer filing cabinet  
464W x 616D x 1020H mm.

**DD - 992 C**  
2 drawer filing cabinet  
for foolscap  
464W x 616D x 720H mm.



**DD - 994 P**  
4 drawer filing cabinet  
464W x 616D x 1320H mm.

**DD - 993 P**  
3 drawer filing cabinet  
464W x 616D x 1020H mm.

**DD - 992 P**  
2 drawer filing cabinet  
for foolscap  
464W x 616D x 720H mm.



**DD - 994 S**  
4 drawer filing cabinet  
464W x 616D x 1320H mm.

**DD - 993 S**  
3 drawer filing cabinet  
464W x 616D x 1020H mm.

**DD - 992 S**  
2 drawer filing cabinet  
for foolscap  
464W x 616D x 720H mm.

BODY COLOR : CREAM (#180)  
COLOR MAY NOT BE EXACTLY SHOWN

## Vertical filing cabinets



**D - 744**  
4 drawer filing cabinet  
464W x 616D x 1320H mm.

**D - 743**  
3 drawer filing cabinet  
464W x 616D x 1020H mm.

**D - 742**  
2 drawer filing cabinet  
for foolscap  
464W x 616D x 720H mm.



**DA - 104**  
4 drawer filing cabinet  
464W x 616D x 1320H mm.

**DA - 103**  
3 drawer filing cabinet  
464W x 616D x 1020H mm.

**DA - 102**  
2 drawer filing cabinet  
for foolscap  
464W x 616D x 720H mm.



**D - 814**  
4 drawer filing cabinet  
for foolscap  
470W x 620D x 1320H mm.

BODY COLOR : CREAM (#180)  
COLOR MAY NOT BE EXACTLY SHOWN

BODY COLOR : GRAY (#140)  
DRAWER COLOR : LIGHT GRAY (#150)  
COLOR MAY NOT BE EXACTLY SHOWN  
(OPTIONAL)

CREAM (#180)  
COLOR MAY NOT BE EXACTLY SHOWN

DARK GRAY (#170)  
COLOR MAY NOT BE EXACTLY SHOWN  
(OPTIONAL)

CREAM (#180)  
COLOR MAY NOT BE EXACTLY SHOWN

DARK GRAY (#170)  
COLOR MAY NOT BE EXACTLY SHOWN  
(OPTIONAL)



## Overlay cabinets



### D - 5048

5 drawer overlay cabinet  
1118W x 1220D x 510H mm.

### D - 4032

5 drawer overlay cabinet  
1118W x 814D x 510H mm.

## Base for overlay cabinets



### S - 032

base for overlay cabinet  
1118W x 814D x 290H mm.

### S - 048

base for overlay cabinet  
1118W x 1220D x 290H mm.



### S - 1032

base for overlay cabinet  
1118W x 814D x 150H mm.

### S - 1048

base for overlay cabinet  
1118W x 1220D x 150H mm.



**CREAM (#180)**  
COLOR MAY NOT BE EXACTLY SHOWN



**DARK GRAY (#170)**  
COLOR MAY NOT BE EXACTLY SHOWN  
(OPTIONAL)

## Card index cabinets



**D - 205**  
5 drawer card index cabinet  
541W x 616D x 1322H mm.

**D - 204**  
4 drawer card index cabinet  
541W x 616D x 807H mm.



**D - 207**  
7 drawer card index cabinet  
541W x 616D x 1322H mm.

**D - 206**  
6 drawer card index cabinet  
541W x 616D x 1322H mm.



**D - 211**  
11 drawer card index cabinet  
364W x 616D x 1545H mm.

**D - 209**  
9 drawer card index cabinet  
364W x 616D x 1286H mm.



**DR - 115**  
15 drawer card index cabinet  
278W x 459D x 922H mm.

**DR - 110**  
10 drawer card index cabinet  
278W x 459D x 653H mm.



**DR - 215**  
15 drawer card index cabinet  
375W x 459D x 1262H mm.

**DR - 210**  
10 drawer card index cabinet  
375W x 459D x 882H mm.

 **CREAM (#180)**  
COLOR MAY NOT BE EXACTLY SHOWN

 **DARK GRAY (#170)**  
COLOR MAY NOT BE EXACTLY SHOWN  
(OPTIONAL)



**FA - 407**  
7 drawer card index cabinet  
265W x 381D x 388H mm.

**FA - 405**  
5 drawer card index cabinet  
265W x 381D x 296H mm.



**FA - 412**  
12 drawer card index cabinet  
265W x 381D x 618H mm.

**FA - 410**  
10 drawer card index cabinet  
265W x 381D x 526H mm.

 **CREAM (#180)**  
COLOR MAY NOT BE EXACTLY SHOWN

## Accessories for storage cupboards



### PLAIN SHELF

**S - SH - 996 S**

912W x 398D x 30H mm.

2

### ROLL - OUT SHELF

**PS - SH - 996 S**

850W x 400D x 220H mm.

1

### ROLL - OUT DRAWERS

**B - SH - 996 S**

800W x 396D x 122H mm.

1

### ROLL - OUT SUSPENSION FILING FRAME

**F - SH - 996 S**

850W x 410D x 82H mm.

1 2 4

**BODY COLOR : CREAM (#180)**  
COLOR MAY NOT BE EXACTLY SHOWN

**BODY COLOR : PUTTY (#193)**  
COLOR MAY NOT BE EXACTLY SHOWN  
(OPTIONAL)

**ACCESSORIES COLOR : FLAT BLACK (#130)**  
COLOR MAY NOT BE EXACTLY SHOWN

## Storage cupboards



**SH - 994 P**

915W x 457D x 1067H mm.



**SH - 996 P**

915W x 457D x 1829H mm.



**SH - 998 P**

915W x 457D x 1980H mm.

**BODY COLOR : CREAM (#180)**  
COLOR MAY NOT BE EXACTLY SHOWN

**BODY COLOR : PUTTY (#193)**  
COLOR MAY NOT BE EXACTLY SHOWN  
(OPTIONAL)

## Storage cupboards



### SH - 754

double swing door cabinet  
with 2 shelves  
917W x 457D x 1219H mm.



**BODY COLOR : CREAM (#180)**  
COLOR MAY NOT BE EXACTLY SHOWN



**BODY COLOR : GRAY (#140)**  
**DRAWER COLOR : LIGHT GRAY (#150)**  
COLOR MAY NOT BE EXACTLY SHOWN  
(OPTIONAL)



### SH - 756

double swing door cabinet  
with 3 shelves  
917W x 457D x 1829H mm.



### SH - 104

double swing door cabinet  
with 3 shelves  
917W x 457D x 1829H mm.



**BODY COLOR : CREAM (#180)**  
COLOR MAY NOT BE EXACTLY SHOWN



**BODY COLOR : DARK GRAY (#170)**  
COLOR MAY NOT BE EXACTLY SHOWN  
(OPTIONAL)



### SH - 816

double swing door cabinet  
with 3 shelves  
914W x 457D x 1829H mm.







## COMPACTUS FILING & STORAGE

ตู้คอมแพคตัส "ลักกี้" เป็นระบบตู้รางเลื่อนประหยัดพื้นที่ ออกแบบเพื่อเก็บสิ่งของได้เป็นจำนวนมาก และอเนกประสงค์ เช่น เอกสาร อุปกรณ์เครื่องมือต่างๆ มีความแข็งแรง ทนทาน และ รูปแบบสวยงาม ทันสมัย เหมาะสำหรับใช้ในสถานที่ต่างๆ เช่น อาคารสำนักงาน โรงแรม โรงพยาบาล ฯลฯ

"Lucky" Compactus cabinets are mobile storage system which helps in saving space. The system is designed to suit for applications in storing a large number of items and multi-purpose usage such as documents, tools and equipment. The cabinets are strong and durable, as well as the design is attractive and modern which is suitable for use in various places such as office building, hotel, hospital, etc.





# COMPACTUS

Mobile storage cabinets series 1

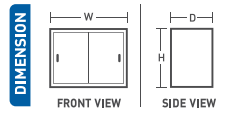

FILING & STORAGE

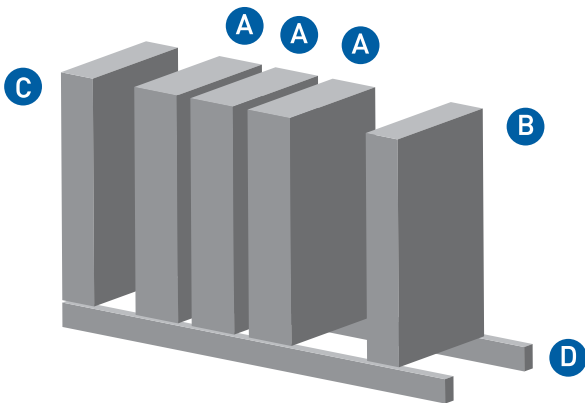

## MOBILE STORAGE CABINET

- A B C D** IEM - 100  
4800W x 915D x 2006H mm.
- A** IEM - 101  
916W x 915D x 1930H mm.
- B** IEM - 102  
916W x 457D x 1930H mm.
- C** IEM - 103  
916W x 457D x 1930H mm.
- D** IEM - 104  
4800W x 25D x 76H mm.



BODY COLOR : CREAM (#180)  
COLOR MAY NOT BE EXACTLY SHOWN



RAIL COLOR : FLAT BLACK (#130)  
COLOR MAY NOT BE EXACTLY SHOWN



## Mobile storage cabinets series 2



Laem Chabang Port Customs Bureau ;  
Mobile Storage Cabinets



Thailand Post ; Mobile Storage Cabinets

## Mobile storage cabinets series 2

MOBILE SERIES 2	SIZE (W x D x H) mm.	ISOMETRIC
IEM - 200	4800 x 2136 x 2370	
IEM - 201	800 x 2136 x 2340	
IEM - 202	422 x 2136 x 2340	
IEM - 203	422 x 2136 x 2340	
IEM - 204	4800 x 168 x 25	
IEM - 300	4800 x 3136 x 2370	
IEM - 301	800 x 3136 x 2340	
IEM - 302	422 x 3136 x 2340	
IEM - 303	422 x 3136 x 2340	
IEM - 204	4800 x 168 x 25	
IEM - 400	4800 x 4181 x 2370	
IEM - 401	800 x 4181 x 2340	
IEM - 402	422 x 4181 x 2340	
IEM - 403	422 x 4181 x 2340	
IEM - 204	4800 x 168 x 25	
IEM - 500	4800 x 5181 x 2370	
IEM - 501	800 x 5181 x 2340	
IEM - 502	422 x 5181 x 2340	
IEM - 503	422 x 5181 x 2340	
IEM - 204	4800 x 168 x 25	
IEM - 600	4800 x 6181 x 2370	
IEM - 601	800 x 6181 x 2340	
IEM - 602	422 x 6181 x 2340	
IEM - 603	422 x 6181 x 2340	
IEM - 204	4800 x 168 x 25	



# LOCKER

## FILING & STORAGE

ตู้ล็อกเกอร์ “ลัคกี้” มีความแข็งแรงทนทานและรูปแบบสวยงาม ออกแบบเพื่อเก็บสิ่งของอเนกประสงค์ อาทิ เอกสาร เสื้อผ้า และอุปกรณ์กีฬา เป็นต้น ทุกตู้มีช่องระบายอากาศ เหมาะสำหรับใช้ในสถานที่ต่างๆ เช่น สำนักงาน โรงแรม โรงพยาบาล สโมสรดคลับ สถาบันการศึกษา โรงงาน อุตสาหกรรม และบ้านพักอาศัย มีให้เลือกมากมายหลายรูปแบบ

"Lucky" Lockers are robust and beautiful design with ventilated channel in every compartment. It is designed for keeping various item such as document, clothes and sport accessories, etc. There are several models for selection which all are suitable for office, hotel, hospital, sport club, educational institute, factory, home, etc.







# LOCKER

## Filing & Storage

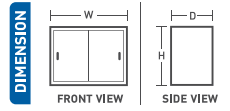

FILING & STORAGE



**LK - 6102**  
 double swing door locker  
 917W x 533D x 1829H mm.



**LK - 6103**  
 3 swing door locker  
 917W x 457D x 1829H mm.



**LK - 6106**  
 6 swing door locker  
 917W x 457D x 1829H mm.



**LK - 6109**  
 9 swing door locker  
 917W x 457D x 1829H mm.



**LK - 6112**  
 12 swing door locker  
 917W x 457D x 1829H mm.



**LK - 6118**  
 18 swing door locker  
 917W x 457D x 1829H mm.

 BODY COLOR : CREAM (#180)  
 COLOR MAY NOT BE EXACTLY SHOWN

 COLOR : GRAY (#140)  
 COLOR : LIGHT GRAY (#150)  
 COLOR MAY NOT BE EXACTLY SHOWN  
 (OPTIONAL)

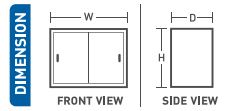

## Locker



**LK - 991**  
1 swing door locker  
305W x 381D x 1829H mm.



**LK - 992**  
double swing door locker  
305W x 381D x 1829H mm.



**LK - 993**  
3 swing door locker  
305W x 381D x 1829H mm.



**LK - 994**  
4 swing door locker  
305W x 381D x 1829H mm.



**LK - 996**  
6 swing door locker  
305W x 381D x 1829H mm.



BODY COLOR : SEMI GLOSS GREY (#151)  
COLOR MAY NOT BE EXACTLY SHOWN



BODY COLOR : CREAM (#180)  
COLOR MAY NOT BE EXACTLY SHOWN  
(OPTIONAL)

# Feature & Benefit



Umbrella Holder



Clothes Hanging



Upper shelf and hanging rail



Ventilated bottom shoe compartment

# DESK & TABLE

"Kingdom" desks & tables: there are various models of desks & tables for selection according to applications such as desk, pedestal, type-writing table, drawing table, and meeting table, etc. They are carefully designed for convenience in using and are manufactured under the modern technology and the best selected materials.

okamura





# EXECUTIVE DESK

## DESK & TABLE

โต๊ะทำงานสำหรับผู้บริหาร ออกแบบให้มีความสง่างาม ภูมิฐาน พร้อมกับฟังก์ชันการใช้งานที่หลากหลาย สะท้อนถึงคุณลักษณะของผู้นำ ที่ผสมผสานบุคลิกที่โดดเด่น และมีความสามารถเข้ากันอย่างลงตัว

Executive desks are specially designed with elegance and a wide range of applications which reflect the outstanding personality of executives.







# DESKS

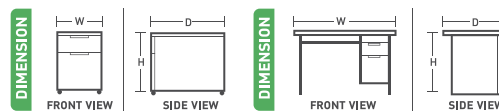

## Executive Desk

### TYPE A



- EXT A - 90180** 1800W x 900D x 750H mm.
- EXT A - 90200** 2000W x 900D x 750H mm.
- EXT A - 90240** 2400W x 900D x 750H mm.

### TYPE B



- EXT B - 90180** 2250W x 900D x 750H mm.
- EXT B - 90200** 2450W x 900D x 750H mm.
- EXT B - 90240** 2850W x 900D x 750H mm.

### TYPE C



- EXT C - 90180** 2250W x 900D x 750H mm.
- EXT C - 90200** 2450W x 900D x 750H mm.
- EXT C - 90240** 2850W x 900D x 750H mm.

### TYPE D



- EXT D - 90180** 1800W x 1500D x 750H mm.
- EXT D - 90200** 2000W x 1500D x 750H mm.
- EXT D - 90240** 2400W x 1500D x 750H mm.

### TYPE E



- EXT E - 90180** 1800W x 1800D x 750H mm.
- EXT E - 90200** 2000W x 1800D x 750H mm.
- EXT E - 90240** 2400W x 1800D x 750H mm.

 **WORK TOP COLOR : BLACK HI-GROSSED**  
COLOR MAY NOT BE EXACTLY SHOWN

 **BODY : HIGH PRESSURE LIMINATE (HPL)**  
COLOR MAY NOT BE EXACTLY SHOWN



## DESK

### DESK & TABLE

ชุดโต๊ะสำนักงานอเนกประสงค์ ผ่านการออกแบบและพัฒนา เพื่อรองรับการใช้งานของสำนักงานสมัยใหม่ สามารถปรับเปลี่ยนฟังก์ชันการใช้งานได้หลากหลายรูปแบบ พร้อมรองรับการเพิ่มเติมชุดเฟอร์นิเจอร์สำนักงาน เพื่ออำนวยความสะดวกแก่ผู้ใช้งานได้อย่างลงตัว

Multi-purpose office desks are designed and developed for modern office. The function can be modified in various types and can support the furniture expansion to facilitate its work perfectly.

okamura





# DESKS

## Free standing desk

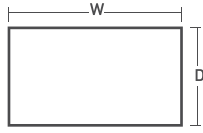

### RECTANGULAR DESKS

- B4IRD8** 800 x 800 x 725 mm.
- B4IRD12** 1180 x 800 x 725 mm.
- B4IRD14** 1400 x 800 x 725 mm.
- B4IRD16** 1600 x 800 x 725 mm.

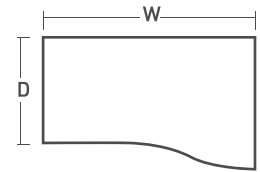

### WAVE DESKS (Right hand or Left hand)

- B4IWDR12** 1180 x 1000/800 x 725 mm.
- B4IWDR14** 1400 x 1000/800 x 725 mm.
- B4IWDR16** 1600 x 1000/800 x 725 mm.

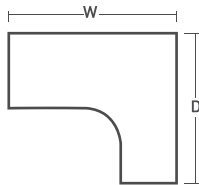

### LARGE WORKSTATIONS

(Right hand or Left hand)

- B4IWR1616** 1600 x 1600/800/600 x 725 mm.
- B4IWR1816** 1800 x 1600/800/600 x 725 mm.

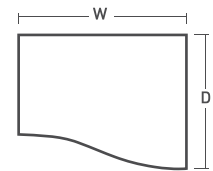

### WAVE RETURNS

(Right hand or Left hand)

- B4IWR** 1000 x 600/800 x 725 mm.

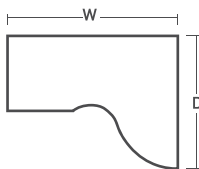

### DELTA WORKSTATIONS

(Right hand or Left hand)

- B4IDWR16** 1600 x 1400/800 x 725 mm.
- B4IDWR18** 1800 x 1400/800 x 725 mm.

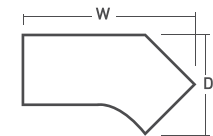

### 135° WORKSTATIONS

(Right hand or Left hand)

- B4I135WR14** 1400/800 x 800/800 x 725 mm.
- B4I135WR16** 1600/800 x 800/800 x 725 mm.

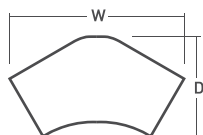

### 120° WORKSTATIONS

- B4I120W8** 1200/1200 x 800/800 x 725 mm.
- B4I120W6** 1200/1200 x 600/600 x 725 mm.

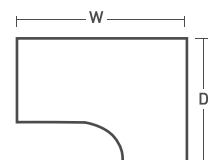

### WORKSTATIONS

(Right hand or Left hand)

- B4IWR12** 1180 x 1180/800/600 x 725 mm.
- B4IWR14** 1400 x 1180/800/600 x 725 mm.
- B4IWR16** 1600 x 1180/800/600 x 725 mm.
- B4IWR18** 1800 x 1180/800/600 x 725 mm.



WORK TOP COLOR : HIGH PRESSURE LAMINATE (PP 6451 UN) COLOR MAY NOT BE EXACTLY SHOWN



BODY COLOR : SILVER (#251) COLOR MAY NOT BE EXACTLY SHOWN



## Desks



**NT - 2436**  
914W x 610D x 750H mm.

**NT - 2642**  
1067W x 660D x 750H mm.

**NT - 2648**  
1219W x 660D x 750H mm.



**NT - 2654**  
1372W x 660D x 750H mm.

**NT - 3060**  
1524W x 762D x 750H mm.

**NT - 3472**  
1829W x 864D x 750H mm.

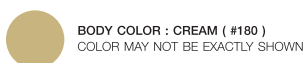

**NTN - 2436**  
914W x 610D x 750H mm.

**NTN - 2642**  
1067W x 660D x 750H mm.

**NTN - 2648**  
1219W x 660D x 750H mm.



**NTN - 2654**  
1372W x 660D x 750H mm.

**NTN - 3060**  
1524W x 762D x 750H mm.

**NTN - 3472**  
1829W x 864D x 750H mm.



**TC - 2436**  
914W x 610D x 750H mm.

**TC - 2642**  
1067W x 660D x 750H mm.

**TC - 2648**  
1219W x 660D x 750H mm.



**TC - 2654**  
1372W x 660D x 750H mm.

**TC - 3060**  
1524W x 762D x 750H mm.

**TC - 3472**  
1829W x 864D x 750H mm.



**NTC - 2436**  
914W x 610D x 750H mm.

**NTC - 2642**  
1067W x 660D x 750H mm.

**NTC - 2648**  
1219W x 660D x 750H mm.



**NTC - 2654**  
1372W x 660D x 750H mm.

**NTC - 3060**  
1524W x 762D x 750H mm.

**NTC - 3472**  
1829W x 864D x 750H mm.



**CF - 90180 ( 1 UNIT )**  
1800W x 900D x 750H mm.



**SDT - 200**  
400W x 630D x 650H mm.



**COMBINET SET**  
**CF - 90180 ( 1 UNIT )**  
**SDT - 200 ( 2 UNIT )**  
1800W x 900D x 750H mm.





## Side desks



**NT - 1626**  
412W x 665D x 750H mm.



**NTN - 1626**  
412W x 665D x 750H mm.



WORK TOP COLOR  
: HIGH PRESSURE LAMINATE (TD 9325 PL)  
COLOR MAY NOT BE EXACTLY SHOWN



WORK TOP COLOR  
: HIGH PRESSURE LAMINATE (PP 3737 UN)  
COLOR MAY NOT BE EXACTLY SHOWN



BODY COLOR : CREAM (#180)  
COLOR MAY NOT BE EXACTLY SHOWN



**CT - 70150**  
1490W x 690D x 985H mm.

**CT - 70180**  
1795W x 690D x 985H mm.

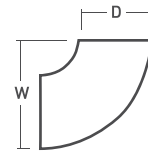

**CTO - 45140**  
690W x 455D x 985H mm.



WORKTOP COLOR  
: HIGH PRESSURE LAMINATE (NO. PF 1192 UN)  
COLOR MAY NOT BE EXACTLY SHOWN



BODY COLOR : NEW IVORY (#280)  
COLOR MAY NOT BE EXACTLY SHOWN

## Counter sets



**TCR - 80150**  
1500W x 800D x 935H mm.

**TCR - 80180**  
1800W x 800D x 935H mm.



**TCL - 80150**  
1500W x 800D x 935H mm.

**TCL - 80180**  
1800W x 800D x 935H mm.



WORK TOP COLOR  
: HIGH PRESSURE LAMINATE (PP 7010 UN)  
COLOR MAY NOT BE EXACTLY SHOWN



BODY COLOR : CREAM (#180)  
COLOR MAY NOT BE EXACTLY SHOWN



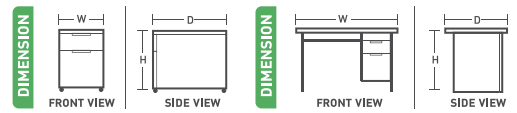

### Flat desks (2 drawers)



**D - 75100**  
1000W x 750D x 750H mm.

**D - 75120**  
1200W x 750D x 750H mm.

- WORKTOP COLOR**  
: HIGH PRESSURE LAMINATE (NO. PP 6451 UN)  
COLOR MAY NOT BE EXACTLY SHOWN
- BODY COLOR : NEW IVORY (#280)**  
COLOR MAY NOT BE EXACTLY SHOWN



**DP - 70100**  
1000W x 700D x 750H mm.

- WORK TOP COLOR**  
: HIGH PRESSURE LAMINATE (PP 0927 UN)  
COLOR MAY NOT BE EXACTLY SHOWN
- BODY COLOR : SEMI GLOSS GREY (#151)**  
COLOR MAY NOT BE EXACTLY SHOWN

### L- shaped desks (2 drawers on left or right)

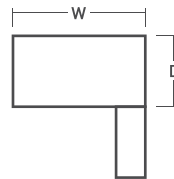

**DL 2 - 75140 L, R**  
1400W x 750D x 750H mm.

**DL 2 - 75160 L, R**  
1600W x 750D x 750H mm.

**DL 2 - 90180 L, R**  
1800W x 900D x 750H mm.

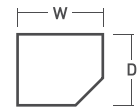

**DC - 7590**  
900W x 750D x 750H mm.

### (3 drawers on left or right)



**DL 3 - 75140 L, R**  
1400W x 750D x 750H mm.

**DL 3 - 90180 L, R**  
1800W x 900D x 750H mm.

**DL 3 - 75160 L, R**  
1600W x 750D x 750H mm.

**DL 3 - 90180 L, R**  
1800W x 900D x 750H mm.

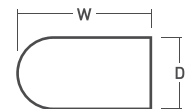

**DM - 75140**  
1400W x 750D x 750H mm.

**DM - 75160**  
1600W x 750D x 750H mm.

- WORKTOP COLOR**  
: HIGH PRESSURE LAMINATE (NO. PP 6451 UN)  
COLOR MAY NOT BE EXACTLY SHOWN
- BODY COLOR : NEW IVORY (#280)**  
COLOR MAY NOT BE EXACTLY SHOWN



## Single pedestal desks

(2 drawers on left or right)

(3 drawers on left or right)



**D 2 - 75100 L, R**

1000W x 750D x 750H mm.

**D 2 - 75120 L, R**

1200W x 750D x 750H mm.

**D 2 - 75140 L, R**

1400W x 750D x 750H mm.



**D 3 - 75100 L, R**

1000W x 750D x 750H mm.

**D 3 - 75120 L, R**

1200W x 750D x 750H mm.

**D 3 - 75140 L, R**

1400W x 750D x 750H mm.



**DP 3 - 70100 L, R**

1000W x 700D x 750H mm.

**DP 3 - 70120 L, R**

1200W x 700D x 750H mm.



WORKTOP COLOR  
: HIGH PRESSURE LAMINATE (NO. PP 6451 UN)  
COLOR MAY NOT BE EXACTLY SHOWN



BODY COLOR : NEW IVORY (#280)  
COLOR MAY NOT BE EXACTLY SHOWN



WORK TOP COLOR  
: HIGH PRESSURE LAMINATE (PP 0927 UN)  
COLOR MAY NOT BE EXACTLY SHOWN



BODY COLOR : SEMI GROSS GREY (#151)  
COLOR MAY NOT BE EXACTLY SHOWN

## Double pedestal desks

(3 drawers on left or right, 2 on right)

(2 drawers on left, 3 on right)



**D 32 - 75140**

1400W x 750D x 750H mm.

**D 32 - 75160**

1600W x 750D x 750H mm.

**D 32 - 90180**

1800W x 900D x 750H mm.



**D 23 - 75140**

1400W x 750D x 750H mm.

**D 23 - 75160**

1600W x 750D x 750H mm.

**D 23 - 90180**

1800W x 900D x 750H mm.



**DP 23 - 75150**

1500W x 750D x 750H mm.

**DP 23 - 75180**

1800W x 750D x 750H mm.



WORKTOP COLOR  
: HIGH PRESSURE LAMINATE (NO. PP 6451 UN)  
COLOR MAY NOT BE EXACTLY SHOWN



BODY COLOR : NEW IVORY (#280)  
COLOR MAY NOT BE EXACTLY SHOWN



WORK TOP COLOR  
: HIGH PRESSURE LAMINATE (PP 0927 UN)  
COLOR MAY NOT BE EXACTLY SHOWN



BODY COLOR : SEMI GROSS GREY (#151)  
COLOR MAY NOT BE EXACTLY SHOWN

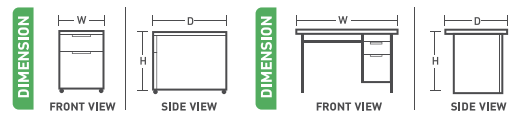

## Pedestal side desks



**DS 2 - 7540**  
410W x 750D x 750H mm.

**DS 2 - 9040**  
410W x 900D x 750H mm.



**DS 3 - 7540**  
410W x 750D x 750H mm.

**DS 3 - 9040**  
410W x 900D x 750H mm.



**PDR - 2026 - 2D**  
372W x 500D x 685H mm.



**PDR - 2026 - 3D**  
372W x 500D x 685H mm.

 **WORKTOP COLOR**  
: HIGH PRESSURE LAMINATE (NO. PP 6451 UN)  
COLOR MAY NOT BE EXACTLY SHOWN

 **BODY COLOR : NEW IVORY (#280)**  
COLOR MAY NOT BE EXACTLY SHOWN

 **BODY COLOR : SEMI GROSS GREY (#151)**  
COLOR MAY NOT BE EXACTLY SHOWN

## Mobile drawer unit ; 2 drawers with casters



**DP 2 - 6040**  
410W x 600D x 630H mm.



**PDR - 2020 - 2D ( M )**  
372W x 500D x 580H mm.

 **WORKTOP COLOR**  
: HIGH PRESSURE LAMINATE (NO. PP 6451 UN)  
COLOR MAY NOT BE EXACTLY SHOWN

 **BODY COLOR : NEW IVORY (#280)**  
COLOR MAY NOT BE EXACTLY SHOWN

 **BODY COLOR : SEMI GROSS GREY (#151)**  
COLOR MAY NOT BE EXACTLY SHOWN



## Computer table sets



**TNS - 4565**  
650W x 750D x 1350H mm.



WORK TOP COLOR  
: HIGH PRESSURE LAMINATE (TD 9989 PL)  
COLOR MAY NOT BE EXACTLY SHOWN



BODY COLOR : NEW IVORY (#280)  
COLOR MAY NOT BE EXACTLY SHOWN



**TNS - 45100**  
1000W x 750D x 1350H mm.



**TNS - 6585**  
645W x 850D x 1150H mm.



**TEC - 70100**  
1000W x 700D x 686H mm.



WORK TOP COLOR  
: HIGH PRESSURE LAMINATE (PP 7010 UN)  
COLOR MAY NOT BE EXACTLY SHOWN



BODY COLOR : NEW IVORY (#280)  
COLOR MAY NOT BE EXACTLY SHOWN



**TEN - 7070**  
700W x 700D x 750H mm.



**TEN - 70100**  
1000W x 700D x 750H mm.



WORK TOP COLOR  
: HIGH PRESSURE LAMINATE (PP 7934 UN)  
COLOR MAY NOT BE EXACTLY SHOWN



BODY COLOR : CREAM (#180)  
COLOR MAY NOT BE EXACTLY SHOWN



**TEN - 70120**  
1200W x 700D x 750H mm.

## Drawing tables



**SDT - 100**  
395W x 555D x 665H mm.



BODY COLOR : CREAM (#180)  
COLOR MAY NOT BE EXACTLY SHOWN

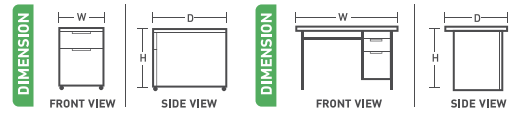

## Okamura OA desks

### Double pedestal desks

(3 drawer pedestal on left hand side)



**DH03ZA (DB03ZA)** 1600W x 800D x 750H(700H) mm.  
**DH03ZD (DB03ZD)** 1400W x 700D x 750H(700H) mm.

**DH03ZB (DB03ZB)** 1600W x 700D x 750H(700H) mm.

(4 drawer single pedestal desk)



**DH04ZA (DB04ZA)** 1600W x 800D x 750H(700H) mm.  
**DH04ZD (DB04ZD)** 1400W x 700D x 750H(700H) mm.

**DH04ZB (DB04ZB)** 1600W x 700D x 750H(700H) mm.

### Single pedestal desks : Panel leg type

(3 drawer single pedestal desk)



**DH13ZE (DB13ZE)** 1200W x 800D x 750H(700H) mm.  
**DH13ZL (DB13ZL)** 1000W x 700D x 750H(700H) mm.

**DH13ZF (DB13ZF)** 1200W x 700D x 750H(700H) mm.  
**DH13ZM (DB13ZM)** 1000W x 600D x 750H(700H) mm.

**DH13ZP (DB13ZP)** 1100W x 700D x 750H(700H) mm.

(4 drawer single pedestal desk)



**DH14ZE (DB14ZE)** 1200W x 800D x 750H(700H) mm.  
**DH14ZL (DB14ZL)** 1000W x 700D x 750H(700H) mm.

**DH14ZF (DB14ZF)** 1200W x 700D x 750H(700H) mm.  
**DH14ZM (DB14ZM)** 1000W x 600D x 750H(700H) mm.

**DH14ZP (DB14ZP)** 1100W x 700D x 750H(700H) mm.

### Single pedestal desks : L-shaped leg type

(3 drawer single pedestal desk)



**DH13LE (DB13LE)** 1200W x 800D x 750H(700H) mm.  
**DH13LL (DB13LL)** 1000W x 700D x 750H(700H) mm.

**DH13LF (DB13LF)** 1200W x 700D x 750H(700H) mm.

**DH13LP (DB13LP)** 1100W x 700D x 750H(700H) mm.

(4 drawer single pedestal desk)



**DH14LE (DB14LE)** 1200W x 800D x 750H(700H) mm.  
**DH14LL (DB14LL)** 1000W x 700D x 750H(700H) mm.

**DH14LF (DB14LF)** 1200W x 700D x 750H(700H) mm.

**DH14LP (DB14LP)** 1100W x 700D x 750H(700H) mm.

### Slim double pedestal desks

(3 drawer single pedestal desk)



**DH01ZD (DB01ZD)**

1400W x 700D x 750H (700H) mm.

(4 drawer slim pedestal double pedestal desk)



**DH02ZD (DB02ZD)**

1400W x 700D x 750H (700H) mm.

(3 drawer single pedestal desk)



**DH11ZL (DB11ZL)**

1000W x 700D x 750H (700H) mm.

**DH11ZM (DB11ZM)**

1000W x 600D x 750H (700H) mm.

(4 drawer single pedestal desk)



**DH12ZL (DB12ZL)**

1000W x 700D x 750H (700H) mm.

**DH12ZM (DB12ZM)**

1000W x 600D x 750H (700H) mm.

(3 drawer single pedestal desk)



**DH11LL (DB11LL)**

1000W x 700D x 750H (700H) mm.

**DH11LM (DB11LM)**

1000W x 600D x 750H (700H) mm.

(4 drawer single pedestal desk)



**DH12LL (DB12LL)**

1000W x 700D x 750H (700H) mm.

**DH12LM (DB12LM)**

1000W x 600D x 750H (700H) mm.



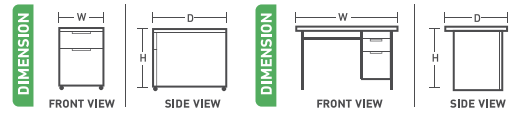

## Flat desks

### L - shaped leg type



#### DH20LE (D320LE)

1200W x 800D x 750H (700H) mm.

#### DH20LF (D320LF)

1200W x 700D x 750H (700H) mm.

#### DH20LP (D320LP)

1100W x 700D x 750H (700H) mm.

#### DH20LL (D320LL)

1000W x 700D x 750H (700H) mm.

### Panel leg type



#### DH20ZE (D320ZE)

1200W x 800D x 750H (700H) mm.

#### DH20ZF (D320ZF)

1200W x 700D x 750H (700H) mm.

#### DH20ZP (D320ZP)

1100W x 700D x 750H (700H) mm.

#### DH20ZL (D320ZL)

1000W x 700D x 750H (700H) mm.

#### DH20ZM (D320ZM)

1000W x 600D x 750H (700H) mm.

### L - shaped desk



#### Left Auxiliary

##### DH54XA (DB54XA)

Main Desk : 1600W x 800D x 750H (700H) mm.

Auxiliary Desk : 900W x 450D x 703H (653H) mm.

##### DH54XB (DB54XB)

Main Desk : 1600W x 700D x 750H (700H) mm.

Auxiliary Desk : 900W x 450D x 703H (653H) mm.

Specification : All lock mechanism for the main desk.

#### Right Auxiliary

##### DH54YA (DB54YA)

Main Desk : 1600W x 800D x 750H (700H) mm.

Auxiliary Desk : 900W x 450D x 703H (653H) mm.

##### DH54YB (DB54YB)

Main Desk : 1600W x 700D x 750H (700H) mm.

Auxiliary Desk : 900W x 450D x 703H (653H) mm.

Specification : All lock mechanism for the main desk.

### Work desk



#### DH62ZB (DB62ZB)

1600W x 700D x 750H (700H) mm.

## Okamura OA desks

### Side desks



**DB32AJ**  
400W x 600D x 597H mm.



**DB33AJ**  
400W x 600D x 597H mm.



**DH33ZH (DB33ZH)**  
400W x 800D x 750H (700H) mm.



**DH34ZH (DB34ZH)**  
400W x 800D x 750H (700H) mm.

**DH33ZI (DB33ZI)**  
400W x 700D x 750H (700H) mm.

**DH34ZI (DB34ZI)**  
400W x 700D x 750H (700H) mm.

**DH33ZJ (DB33ZJ)**  
400W x 600D x 750H (700H) mm.

**DH34ZJ (DB34ZJ)**  
400W x 600D x 750H (700H) mm.

## Accessories for Okamura OA desk

### Pin up board



SIZE (W)	WARM BLACK Code No.	NEW IVORY Code No.	COLOR (Code)
1,000	DH46BC	DH46FC	F621, F623, F625
1,100	DH46BD	DH46FD	F626, F631, F632
1,200	DH46BE	DH46FE	F633, F634, F635
1,400	DH46BF	DH46FF	F636, F637, F638
1,600	DH46BG	DH46FG	F639, F640

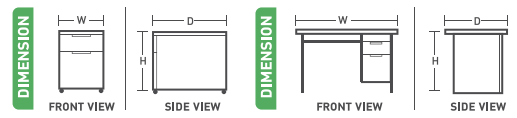

## OA desk system

### Double pedestal desks



**DY03ZA**  
1600W x 800D x 750H mm.

**DY03ZD**  
1400W x 700D x 750H mm.

**DY03ZB**  
1600W x 700D x 750H mm.



**DY04ZA**  
1600W x 800D x 750H mm.

**DY04ZD**  
1400W x 700D x 750H mm.

**DY04ZB**  
1600W x 700D x 750H mm.

### Single pedestal desks



**DY13LE**  
1200W x 800D x 750H mm.

**DY13LP**  
1100W x 700D x 750H mm.

**DY13LF**  
1200W x 700D x 750H mm.

**DY13LL**  
1000W x 700D x 750H mm.



**DY14LE**  
1200W x 800D x 750H mm.

**DY14LP**  
1100W x 700D x 750H mm.

**DY14LF**  
1200W x 700D x 750H mm.

**DY14LL**  
1000W x 700D x 750H mm.

### Flat desks



**DY20LA**  
1600W x 800D x 750H mm.

**DY20LF**  
1200W x 700D x 750H mm.

**DY20LB**  
1600W x 700D x 750H mm.

**DY20LP**  
1100W x 700D x 750H mm.

**DY20LD**  
1400W x 700D x 750H mm.

**DY20LL**  
1000W x 700D x 750H mm.

**DY20LE**  
1200W x 800D x 750H mm.

**DY20LN**  
800W x 800D x 750H mm.

## OA desk system



### Meeting tables



**DY24ZD**  
800W x 1400D x 750H mm.

**DY24ZE**  
800W x 1200D x 750H mm.



**DY24CB**  
800W x 900D x 750H mm.

### Connector end tables



**DY24FA**  
1600W x 800D x 750H mm.

**DY24FD**  
1400W x 700D x 750H mm.

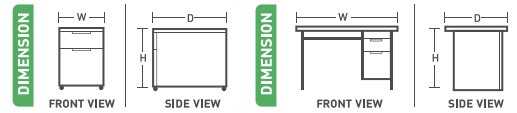

## OA desk system

Round / straight - edged connector tables



**DY24LA**  
800D Left

**DY24LS**  
700D Left

**DY24ZE**  
800D Right

**DY24RS**  
700D Right

For right side connection



**DY20SB**  
400W x 1200D x 750H mm.

Five - side corner tables



**DY24HZ (120°)**  
912W x 700D x 750H mm.

**DY24LZ (90°)**  
1200W x 700D x 750H mm.

L - shaped tables



**DY24ML (LEFT)**  
1600W x 600D x 750H mm.

**DY24MR (RIGHT)**  
1600W x 600D x 750H mm.

**DY24LL (LEFT)**  
1200W x 600D x 750H mm.

**DY24LL (RIGHT)**  
1200W x 600D x 750H mm.

Side desks



**DY34ZH**  
400W x 800D x 750H mm.

**DY34ZI**  
400W x 700D x 750H mm.



**DY33ZH**  
400W x 800D x 750H mm.

**DY33ZI**  
400W x 700D x 750H mm.

Mobile drawer desks



**DY33AJ**  
394W x 580D x 655H mm.



**DY32AJ**  
394W x 580D x 655H mm.

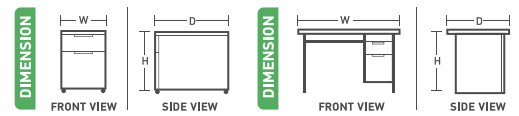

## Accessories for OA desk system

### Desk top panels / pin up boards

- |   |   |
|---|---|
| <b>DY46CG</b><br>1600W x 50D x 350H mm. | <b>DY46CC</b><br>1000W x 50D x 350H mm. |
| <b>DY46CF</b><br>1400W x 50D x 350H mm. | <b>DY46CB</b><br>800W x 50D x 350H mm.  |
| <b>DY46CE</b><br>1200W x 50D x 350H mm. | <b>DY46CS</b><br>400W x 50D x 350H mm.  |
| <b>DY46CD</b><br>1100W x 50D x 350H mm. |   |



### Desk top panels for corner tables

- |                               |                                |
|-------------------------------|--------------------------------|
| <b>DY46HL</b><br>90°, 2 Board | <b>DY46HM</b><br>120°, 2 Board |
| <b>DY46HT</b><br>90°, 3 Board | <b>DY46HX</b><br>120°, 3 Board |



### Desk top panels (2) / (3) for L - shaped tables

- |  |   |
|--|---|
| <b>DY46LB</b><br>1200W x 50D x 350H mm.<br>600W x 50D x 350H mm. | <b>DY46LF</b><br>1200W x 50D x 350H mm.<br>600W x 50D x 350H mm.<br>600W x 50D x 350H mm. |
| <b>DY46LD</b><br>1600W x 50D x 350H mm.<br>600W x 50D x 350H mm. | <b>DY46LH</b><br>1600W x 50D x 350H mm.<br>600W x 50D x 350H mm.<br>600W x 50D x 350H mm. |

### Counter units

- |   |   |
|---|---|
| <b>DY47BG</b><br>1600W x 50D x 350H mm. | <b>DY47BC</b><br>1000W x 50D x 350H mm. |
| <b>DY47BF</b><br>1400W x 50D x 350H mm. | <b>DY47BB</b><br>800W x 50D x 350H mm.  |
| <b>DY47BE</b><br>1200W x 50D x 350H mm. | <b>DY47BS</b><br>400W x 50D x 350H mm.  |
| <b>DY47BD</b><br>1100W x 50D x 350H mm. |   |

### Corner table counter unit

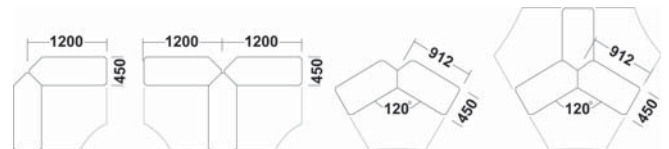

- |                               |                                |
|-------------------------------|--------------------------------|
| <b>DY47BL</b><br>90°, 2 Board | <b>DY47BM</b><br>120°, 2 Board |
| <b>DY47BT</b><br>90°, 3 Board | <b>DY47BX</b><br>120°, 3 Board |

### Side fold tables



- |  |  |
|--|--|
| <b>8184EB</b><br>1800W x 600D x 750H mm. | <b>8184ED</b><br>1500W x 600D x 750H mm. |
| <b>8184EA</b><br>1800W x 450D x 750H mm. | <b>8184EC</b><br>1500W x 450D x 750H mm. |



- |  |  |
|--|--|
| <b>8184EY</b><br>1800W x 600D x 750H mm. | <b>8184EW</b><br>1500W x 450D x 750H mm. |
| <b>8184EX</b><br>1800W x 450D x 750H mm. | <b>8184EZ</b><br>1500W x 600D x 750H mm. |





# FOLDING TABLES

## DESK & TABLE

ชุดโต๊ะเอนกประสงค์ ผ่านการพัฒนาเพื่อสะดวกในการใช้งานและประหยัดพื้นที่ในการจัดเก็บ รองรับการใช้งานได้หลากหลายรูปแบบ พร้อมรูปแบบที่สวยงามจากการออกแบบที่เน้นความเรียบง่ายแต่งดงามตามสไตล์ยุโรป

Multi-purpose folding tables are developed for convenience in use with storage space-saving. They support various functions of usage, with attractive and simple design but elegance as European-style.



# FOLDING TABLES

## Folding tables & Folding step



**TMCT - 70150**

1490W x 690D x 985H mm.

**TMCT - 70180**

1795W x 690D x 985H mm.



WORKTOP COLOR  
: HIGH PRESSURE LAMINATE (NO. TD 8621 PL)  
COLOR MAY NOT BE EXACTLY SHOWN



BODY COLOR : CREAM (#180)  
COLOR MAY NOT BE EXACTLY SHOWN



**CFF - 60120**

1200W x 600D x 760H mm.

**CFF - 60150**

1500W x 600D x 760H mm.

**CFF - 60180**

1800W x 600D x 760H mm.



WORK TOP COLOR  
: HIGH PRESSURE LAMINATE (TD 9210 PL)  
COLOR MAY NOT BE EXACTLY SHOWN

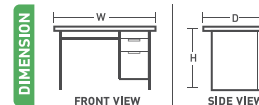

## Folding tables & Folding step



MODEL	SIZE (mm.)		
	W	D	H
TMT - 6090	900	600	750
TMT - 60120	1200	600	750
TMT - 60150	1500	600	750
TMT - 60180	1800	600	750
TMT - 7590	900	750	750
TMT - 75120	1200	750	750
TMT - 75150	1500	750	750
TMT - 75180	1800	750	750

DESK & TABLE



## Table top corner



**TMT - 60 R**  
840W x 600D x 28H mm.

**TMT - 75 R**  
1060W x 750D x 28H mm.



**TMT - 60**  
840W x 600D x 28H mm.

**TMT - 75**  
1060W x 750D x 28H mm.

 WORK TOP COLOR  
: HIGH PRESSURE LAMINATE (PP 7010 UN)  
COLOR MAY NOT BE EXACTLY SHOWN

 BODY COLOR : SEMI GROSS GREY (#151)  
COLOR MAY NOT BE EXACTLY SHOWN



## Size of folding meeting table & Connection type

### TABLE TOP WITH FOLDING LEG

REAL PIC  
+DRAWING

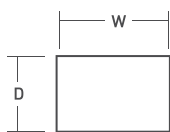

MODEL	SIZE (mm.)	
	W	H
TMT - 6090	600	900
TMT - 60120	600	1200
TMT - 60150	600	1500
TMT - 60180	600	1800
TMT - 7590	750	900
TMT - 75120	750	1200
TMT - 75150	750	1500
TMT - 75180	750	1800

### ROUND CORNER TYPE

REAL PIC  
+DRAWING



MODEL	SIZE (mm.)
	R
TMT - 60R	600
TMT - 75R	750

### STRAIGHT CORNER TYPE

REAL PIC  
+DRAWING

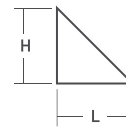

MODEL	SIZE (mm.)	
	H	L
TMT - 60	600	600
TMT - 75	750	750

## Idea lay-out plan of non - corner type

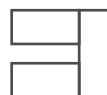

## Idea lay-out plan of "U" type

### ROUND CORNER CONNECTION TYPE

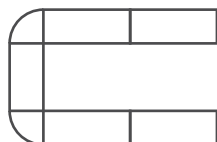
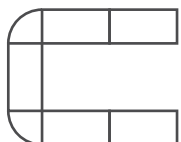

### STRAIGHT CORNER CONNECTION TYPE

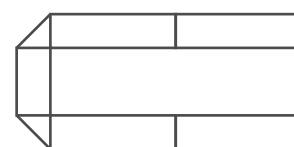
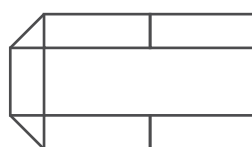
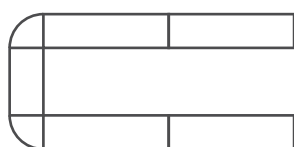
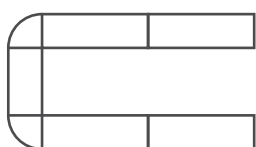
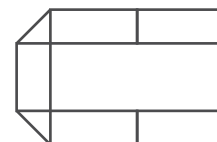
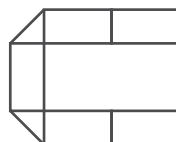

## Idea lay-out plan of "O" type

### ROUND CORNER CONNECTION TYPE

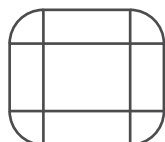
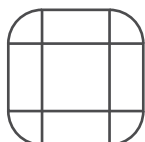

### STRAIGHT CORNER CONNECTION TYPE

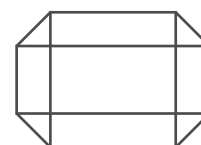
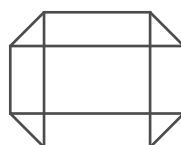
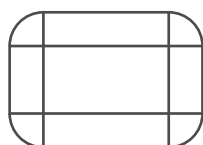
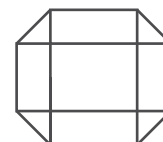
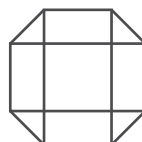





# CONFERENCE TABLES

## DESK & TABLE

ชุดโต๊ะประชุม ที่มีการออกแบบโดยคำนึงถึงรูปแบบการใช้งานเป็นหลัก สามารถรองรับการจัดประชุมหลากหลายรูปแบบ ทั้งในรูปแบบการประชุมแบบวงกลม แบบสี่เหลี่ยม และแบบตัวยู มีความแข็งแรงทนทานและรูปแบบสวยงาม

Conference tables are functionally and flexibly designed to support various meeting styles, such as circular layout, square layout and U-layout. They are also strong, durable with attractive design.



# CONFERENCE TABLES

## Conference tables



**CF - 75120**  
1200W x 750D x 750H mm.

**CF - 75150**  
1500W x 750D x 750H mm.

**CF - 75180**  
1800W x 750D x 750H mm.



**CFM1 - 75120**  
1200W x 750D x 750H mm.

**CFM1 - 75150**  
1500W x 750D x 750H mm.



**CFM2 - 75150**  
1500W x 750D x 750H mm.

**CFM2 - 75180**  
1800W x 750D x 750H mm.



**CFO - 75160**  
1600W x 750D x 750H mm.



**CFO - M1 - 75160**  
1600W x 900D x 750H mm.

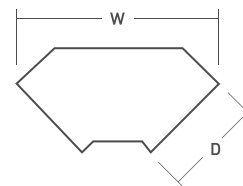

WORK TOP COLOR  
: HIGH PRESSURE LAMINATE (TD 0927 HG)  
COLOR MAY NOT BE EXACTLY SHOWN

BODY COLOR : SEMI GROSS GREY (#151)  
COLOR MAY NOT BE EXACTLY SHOWN



**CFN - 90180**  
1800W x 900D x 750H mm.

WORK TOP COLOR  
: HIGH PRESSURE LAMINATE (PP 7745 UN)  
COLOR MAY NOT BE EXACTLY SHOWN

BODY COLOR : CREAM (#180)  
COLOR MAY NOT BE EXACTLY SHOWN



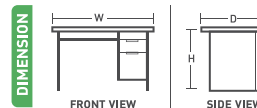

## Conference tables

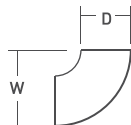

**CFO - 60180**  
900W x 610D x 750H mm.  
1 UNIT

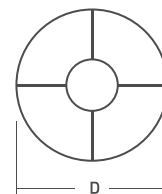

**CFO - 60180**  
1800W x 1800D x 750H mm.  
1 SET ( 4 UNITS)

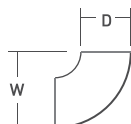

**CFO - 90240**  
1200W x 900D x 750H mm.  
1 UNIT

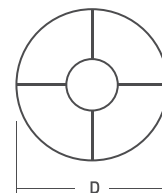

**CFO - 90240**  
2400W x 2400D x 750H mm.  
1 SET ( 4 UNITS)



**CF - 60120**  
1200W x 610D x 750H mm.

**CF - 60150**  
1500W x 610D x 750H mm.

**CF - 60180**  
1800W x 610D x 750H mm.



WORK TOP COLOR  
: HIGH PRESSURE LAMINATE (PP 7010 UN)  
COLOR MAY NOT BE EXACTLY SHOWN



BODY COLOR : CREAM (#180)  
COLOR MAY NOT BE EXACTLY SHOWN



## TABLES

### DESK & TABLE

โต๊ะเนกประสงค์รูปแบบทันสมัย สวยงาม เน้นความหลากหลายในการรองรับการใช้งาน เช่น ใช้เป็นโต๊ะทำงาน ใช้เป็นโต๊ะประชุม ใช้เป็นโต๊ะสำหรับการวางเครื่องใช้สำนักงาน หรือใช้เป็นโต๊ะอาหารจึงสะดวกและช่วยเพิ่มประสิทธิภาพในการทำงาน

Multi-purpose tables are designed with modern and attractive style, as well as multi-functional usages such as working table, conference table, multi-purpose table, dining table, etc. Thus, it is convenient and increases working efficiency.

## General tables



**TN - 75120**  
1200W x 750D x 750H mm.

**TN - 75150**  
1500W x 750D x 750H mm.

**TN - 90180**  
1800W x 900D x 750H mm.



WORK TOP COLOR  
: HIGH PRESSURE LAMINATE (PP 7010 UN)  
COLOR MAY NOT BE EXACTLY SHOWN



**TG - 80120**  
1220W x 760D x 735H mm.

**TG - 80150**  
1520W x 760D x 735H mm.

**TG - 80180**  
1830W x 760D x 735H mm.



**TK - 7676**  
760W x 760D x 720H mm.



**TK - 76120**  
1220W x 760D x 720H mm.

**TK - 76152**  
1520W x 760D x 720H mm.



**TG - 7676**  
760W x 760D x 720H mm.

**TG - 8686**  
860W x 860D x 720H mm.



**TR - 75**  
750W x 750D x 720H mm.

**TR - 90**  
900W x 900D x 720H mm.



WORK TOP COLOR  
: HIGH PRESSURE LAMINATE (TD 9201 HG)  
COLOR MAY NOT BE EXACTLY SHOWN

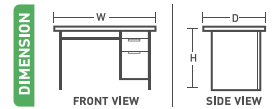

## Folding tables



**TFC - 45180**  
1800W x 450D x 720H mm.

**TFC - 60180**  
1800W x 600D x 720H mm.



**TF - 60150**  
1520W x 600D x 720H mm.

**TF - 60180**  
1830W x 600D x 720H mm.

**TF - 80150**  
1520W x 760D x 720H mm.

**TF - 80180**  
1830W x 760D x 720H mm.



WORK TOP COLOR  
: HIGH PRESSURE LAMINATE (TD 9325 PL)  
COLOR MAY NOT BE EXACTLY SHOWN



**TFN - 45180**  
1800W x 450D x 720H mm.

**TFN - 60180**  
1800W x 600D x 720H mm.



**TFR - 1600**  
1600 diameter x 750H mm.

**TFR - 1800**  
1800 diameter x 750H mm.



WORK TOP COLOR  
: HIGH PRESSURE LAMINATE (TD 9201 HG)  
COLOR MAY NOT BE EXACTLY SHOWN

## SEATING & LOUNGE

"Kingdom", "Chitose" and "Okamura" chairs; there are many models for various applications such as office, hotel, conference room, banquet room, educational institute, etc. Each model is ergonomic designed for more comfort even long-last sitting. The seat height and backrest can be adjusted according to the requirement.

Besides, it is strong and durable because of using the best-selected materials with the strictly controlled manufacturing processes.

**Chitose**





# EXECUTIVE CHAIRS

## SEATING & LOUNGE

เก้าอี้สำนักงานสำหรับผู้บริหาร ที่มีการออกแบบมาให้ดูหรูหรา ทันสมัย โครงสร้างแข็งแรง แสดงถึงความเป็นผู้นำ มีการออกแบบเพื่อรองรับการใช้งานตามสรีระร่างกาย เพื่อให้ใช้งานได้อย่างสบายที่สุด และมีฟังก์ชันการใช้งานเพื่อตอบสนองการใช้งานในหลากหลายรูปแบบ

Executive chairs are luxuriously and stylishly designed with durable structure which is symbolized as an outstanding executive. Each model is ergonomic design for most comfort with functions to serve various types of using.





# EXECUTIVE CHAIRS



## Executive office chairs



CH - 973 1 2 4 5 6  
640W x 715D x 1180H 480SH mm.



CH - 972 1 2 4 5  
605W x 715D x 1130H 460SH mm.



CH - 971 1 2 4 5  
600W x 710D x 980H 450SH mm.

CH - 972 G 1 2 4 5 6  
600W x 710D x 1070H 430SH mm.

CH - 971 G 1 2 4 5 6  
600W x 710D x 930H 430SH mm.



CH - 903 1 2 3 5  
645W x 745D x 1110H 480SH mm.



CH - 902 1 2 3 5  
610W x 685D x 1010H 480SH mm.



CH - 901 1 2 3 5  
610W x 660D x 920H 480SH mm.



CH - 806 1 2 4 5  
720W x 740D x 1160H 500SH mm.



CH - 805 1 2 4 5  
720W x 720D x 1065H 500SH mm.



CH - 804 1 2 4 5  
720W x 700D x 980H 480SH mm.

COLORS OF FABRIC, VINYL AND POLYPROPYLENE. PLEASE SEE PAGE 101

SEATING & LOUNGE



## **TASK CHAIR** SEATING & LOUNGE

เก้าอี้สำนักงาน ที่มีการออกแบบมาเพื่อรองรับการใช้งานตามสรีระร่างกาย และมีฟังก์ชันการใช้งานเพื่อตอบสนองการใช้งานในทุกรูปแบบ โครงสร้างแข็งแรง เพื่อให้ผู้ใช้สามารถทำงานได้อย่างมีประสิทธิภาพมากที่สุด มีรูปแบบและสีให้เลือกหลากหลายรูปแบบ เพื่อให้เหมาะสมและช่วยเสริมสร้างความสวยงามให้กับทุกสถานที่ที่นำไปใช้งานได้อย่างลงตัว

Office chairs are ergonomically designed with durable structure, therefore, the users can work most efficiently. There are many models and colour for various applications.





# TASK CHAIRS

## Task chairs



**CMX - 300 G N13** 1 2 4 5 6  
600W x 670D x 1070H 465SH mm.



**CMX - 200 G N13** 1 2 4 5 6  
707W x 690D x 1030H 475SH mm.



**CMX - 100 G N13** 1 2 4 5 6  
715W x 660D x 930H 460SH mm.



**CEX - 300 G N13** 1 2 4 5 6  
600W x 670D x 1060H 450SH mm.



**CEX - 200 G N13** 1 2 4 5 6  
590W x 650D x 980H 480SH mm.



**CEX - 100 G N13** 1 2 4 5 6  
605W x 640D x 860H 465SH mm.



**CH - 90 GVA** 1 2 4 5 6  
660W x 720D x 1170H 480SH mm.



**CH - 910 EX** 1 2 4 5  
595W x 580D x 1060H 440SH mm.



**CH - 910 A** 1 2 4 5  
610W x 580D x 930H 440SH mm.

## Task chairs



**CH - 910 B** 1 2 4 5  
610W x 645D x 880H 440SH mm.



**CH - 910 C** 1 2  
610W x 590D x 800H 440SH mm.



**FTS - 600 G** 1 2 4 5 6  
650W x 600D x 1038H 440SH mm.

**FTS - 600 S** 1 2 4 5 6  
650W x 600D x 1038H 440SH mm.



**FTS - 500 G** 1 2 4 5 6  
650W x 598D x 810H 440SH mm.



**FTS - 501 G** 1 2 4 5 6  
505W x 598D x 810H 440SH mm.



**GOS - 500 G** 1 2 3 6  
640W x 575D x 880H 450SH mm.



**GOS - 500** 1 2 3  
640W x 575D x 905H 450SH mm.



**GOS - 501 G** 1 2 3 6  
475W x 577D x 890H 458SH mm.



**GOS - 501** 1 2 3  
480W x 575D x 905H 450SH mm.





## Task chairs



**CEM - 100**  
560W x 600D x 840H 440SH mm.



**CEM - 101**  
470W x 545D x 885H 440SH mm.



**CH - 60 A N13** 1 2 4 5  
590W x 640D x 1015H 480SH mm.

**CH - 60 AG N13** 1 2 4 5 6  
590W x 640D x 960H 440SH mm.



**CH - 60 B N13** 1 2 4 5  
590W x 610D x 930H 480SH mm.

**CH - 60 BG N13** 1 2 4 5 6  
590W x 610D x 880H 440SH mm.



**CH - 61 B** 1 2 4 5  
500W x 620D x 920H 488SH mm.

**CH - 61 BG** 1 2 4 5 6  
520W x 610D x 880H 440SH mm.



**CH - 60 C N13** 1 2 4 5  
575W x 600D x 830H 480SH mm.

**CH - 60 CG N13** 1 2 4 5 6  
590W x 580D x 815H 465SH mm.



**CH - 61 C** 1 2 4 5  
520W x 580D x 830H 480SH mm.

**CH - 61 CG** 1 2 4 5 6  
520W x 580D x 780H 440SH mm.



**CH - 18 A** 1 2 4 5  
570W x 730D x 1030H 490SH mm.

**CH - 18 AG** 1 2 4 5 6  
570W x 645D x 980H 430SH mm.



**CH - 18 B** 1 2 4 5  
570W x 630D x 970H 470SH mm.

**CH - 18 BG** 1 2 4 5 6  
570W x 630D x 920H 430SH mm.

## Task chairs



**CH - 18 C** ① ② ④ ⑤  
560W x 615D x 875H 500SH mm.

**CH - 18 CG** ① ② ④ ⑤ ⑥  
575W x 600D x 860H 480SH mm.



**CH - 1400 AG** ① ② ③ ⑤  
600W x 660D x 1045H 450SH mm.



**CH - 1200 A** ① ② ③ ⑤  
595W x 630D x 1010H 450SH mm.



**CH - 1400 G** ① ② ③ ⑤ ⑥  
595W x 575D x 805H 467SH mm.



**CH - 1200** ① ② ③ ⑤  
590W x 570D x 895H 450SH mm.



**CHU - 200** ① ② ④ ⑤  
550W x 530D x 830H 450SH mm.

**CHU - 200 G** ① ② ④ ⑤ ⑥  
550W x 530D x 780H 420SH mm.



**CHU - 201** ① ② ④ ⑤  
470W x 530D x 830H 450SH mm.

**CHU - 201 G** ① ② ④ ⑤ ⑥  
450W x 475D x 817H 445SH mm.



**CH - 1280** ① ②  
460W x 590D x 780H 440SH mm.



**CH - 1290** ① ②  
540W x 600D x 770H 440SH mm.





## Task chairs



**CR - 155** **1 2**  
690W x 710D x 1020H 450SH mm.



**CR - 255** **1 2**  
570W x 619D x 840H 450SH mm.



**CR - 455** **1 2**  
650W x 630D x 755H 450SH mm.



**CR - 355** **1 2**  
550W x 545D x 730H 440SH mm.



**CR - 044** **1 2**  
440W x 500D x 690H 430SH mm.



**CH - 006 A** **1 2 4 5**  
575W x 665D x 914H 450SH mm.



**CH - 006 B** **1 2 4 5**  
575W x 665D x 900H 450SH mm.



**CH - 006 C** **1 2 4 5**  
575W x 530D x 800H 420SH mm.



**CM - 1190**  
575W x 550D x 840H 470SH mm.

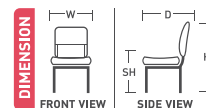

## Task chairs

Comply with JIS.



**CH - 006 D** 1 2  
530W x 565D x 800H 430SH mm.



**CM - 1180**  
530W x 550D x 855H 470SH mm.



**CH - 505** 1 2 3 5  
580W x 545D x 810H 470SH mm.



**CH - 506** 1 2 3 5  
580W x 545D x 810H 470SH mm.



**CM - 006**  
550W x 590D x 790H 440SH mm.



**CH - 400** 1 2 3 5  
590(W) x 530D x 845H 450SH mm.



**CH - 400 A** 1 2 3 5  
470W x 530D x 830H 460SH mm.



**CH - 411** 1 2 3  
610W x 450D x 790H 440SH mm.



**CH - 413** 1 2 3 5  
400W x 440D x 770H 410SH mm.



## Task chairs

Comply with JIS.



CH - 403 1 2 3  
400W x 440D x 780H 430SH mm.



CH - 301 1 2 3  
536W x 455D x 870H 400SH mm.



CH - 300 1 2 3  
455W x 455D x 740H 395SH mm.



CH - 063 1 2 3  
419W x 528D x 830H 430SH mm.



CH - 007 1 2 3  
455W x 570D x 785H 445SH mm.



CH - 007 A 1 2 3  
580W x 570D x 700H 435SH mm.



CH - 304 1 2 3  
535W x 447D x 930H 610SH mm.



CH - 064 1 2 3  
415W x 520D x 995H 605SH mm.



CH - 204 1 2 3  
550W x 520D x 960H 610SH mm.



CH - 405 1 2  
340W x 550D x 490H mm.



CH - 863 B 1 2  
380W x 570D x 435H mm.



CH - 863 C 1 2  
380W x 530D x 435H mm.

COLORS OF FABRIC, VINYL AND POLYPROPYLENE. PLEASE SEE PAGE 101

SEATING & LOUNGE



# MULTI-TASK CHAIRS

## SEATING & LOUNGE

เก้าอี้เนกประสงค์มีหลากหลายรูปแบบ โครงสร้างแข็งแรงเหมาะสมกับการใช้งาน เช่น เก้าอี้รับแขก เก้าอี้พักผ่อน เก้าอี้รับประทานอาหาร เก้าอี้พับ เก้าอี้โกลด์เชอร์ ม้านั่งยาว มีรูปแบบและสีให้เลือกหลากหลายรูปแบบ เพื่อให้เหมาะสม และช่วยเสริมสร้างความสวยงามให้กับทุกสถานที่ที่นำไปใช้งานได้ลงตัว

Multi-purpose chairs are designed in various types with durable structure to suit several usages such as lobby chairs, guest chairs, stacking chairs, folding chairs, lecture chairs, etc. There are many models and colour to suit various applications.

**Chitose**



## Multi-task chairs



**CM - 0815**

540W x 535D x 850H 440SH mm.



**CM - 0825**

520W x 535D x 850H 460SH mm.



**CM - 0816 A**

520W x 535D x 850H 460SH mm.



**CM - 0816 B**

520W x 535D x 835H 460SH mm.



**CM - 0816 LA**

630W x 745D x 850H 460SH mm.



**CM - 0816 LB**

640W x 760D x 850H 460SH mm.



**CM - 60 B**

580W x 600D x 920H 460SH mm.



**CM - 61 B**

500W x 630D x 920H 498SH mm.



**CM - 60 C**

580W x 580D x 830H 460SH mm.



**CM - 61 C**

500W x 580D x 830H 460SH mm.



**CM - 1200**

600W x 540D x 830H 460SH mm.



**CM - 1100**

510W x 540D x 830H 460SH mm.





## Multi-task chairs



**CM - 008**  
590W x 550D x 830H 430SH mm.



**CM - 007**  
590W x 550D x 805H 430SH mm.



**CM - 1190**  
575W x 550D x 840H 470SH mm.



**CM - 1180**  
530W x 550D x 855H 470SH mm.



**CM - 1280**  
460W x 550D x 740H 440SH mm.



**CM - 1290**  
470W x 570D x 810H 440SH mm.



**CM - 910**  
610W x 590D x 835H 440SH mm.



**CM - 2000**  
550W x 570D x 800H 450SH mm.



**CM - 001**  
440W x 550D x 910H 460SH mm.



**CM - 004**  
440W x 550D x 910H 460SH mm.



**CM - 012**  
440W x 560D x 880H 480SH mm.

COLORS OF FABRIC, VINYL AND POLYPROPYLENE. PLEASE SEE PAGE 101



## Multi-task chairs



**CM - 014**  
440W x 577D x 905H 460SH mm.



**CM - 015**  
410W x 530D x 815H 460SH mm.



**CM - 018**  
440W x 580D x 900H 460SH mm.



**CM - 050**  
505W x 490D x 795H 460SH mm.



**CM - 019**  
440W x 580D x 970H 470SH mm.



**CM - 029**  
455W x 580D x 925H 430SH mm.



**SCL - 16 A**  
480W x 500D x 750H 420SH mm.



**LTS - 80 A**  
460W x 505D x 730H 420SH mm.



**LTS - 300 A**  
500W x 515D x 910H 420SH mm.

**SCL - 16 B**  
480W x 500D x 750H 420SH mm.

**LTS - 80 B**  
460W x 505D x 730H 420SH mm.

**LTS - 300 B**  
500W x 515D x 910H 420SH mm.

## Multi-task chairs



**XL - 100**  
540W x 565D x 775H 450SH mm.



**XL - 120**  
610W x 565D x 775H 450SH mm.



**CM - 128**  
510W x 560D x 910H 450SH mm.



DIRECT CONNECTING



**CM - 129**  
620W x 560D x 910H 450SH mm.



DIRECT CONNECTING



**CM - 138**  
540W x 570D x 830H 480SH mm.



DIRECT CONNECTING



**CM - 139**  
580W x 570D x 830H 480SH mm.



DIRECT CONNECTING

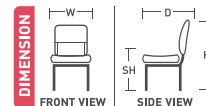

### Multi-task chairs



Comply with JIS.



**CM - 081**

475W x 520D x 770H 430SH mm.



**CM - 033**

335W x 440D x 460SH mm.



**CM - 034**

335W x 440D x 612SH mm.



**CD - 400**

448W x 477D x 737H 420SH mm.



**CD - 500**

448W x 477D x 737H 435SH mm.



**CD - 600**

448W x 490D x 750H 435SH mm.

**CD - 401**

448W x 477D x 737H 420SH mm.

**CD - 501**

448W x 477D x 737H 435SH mm.

**CD - 601**

448W x 490D x 750H 435SH mm.



**CD - 700**

443W x 490D x 750H 435SH mm.



**CD - 800**

464W x 478D x 735H 420SH mm.



**CD - 400 N**

430W x 478D x 735H 420SH mm.

**CD - 701**

443W x 490D x 750H 435SH mm.

**CD - 801**

464W x 478D x 735H 420SH mm.

**CD - 401 N**

430W x 478D x 735H 420SH mm.



**Multi-task chairs** 

Comply with JIS.



**CD - 500 N**  
440W x 485D x 735H 432SH mm.



**CD - 600 N**  
440W x 485D x 735H 432SH mm.



**CD - 700 N**  
440W x 485D x 735H 432SH mm.

**CD - 501 N**  
440W x 485D x 735H 432SH mm.

**CD - 601 N**  
440W x 485D x 735H 432SH mm.

**CD - 701 N**  
440W x 485D x 735H 432SH mm.



**CD - 800 N**  
464W x 478D x 735H 420SH mm.



**CMO - 081**  
590W x 690D x 810H 480SH mm.



**CMO - 004**  
510W x 710D x 910H 460SH mm.

**CD - 801 N**  
464W x 478D x 735H 420SH mm.



**CM - 0817**  
480W x 515D x 850H 460SH mm.



**CM - 0818**  
570W x 545D x 910H 440SH mm.



**CM - 0819**  
640W x 560D x 820H 460SH mm.



**CM - 0819 L**  
580W x 740D x 820H 460SH mm.

**Multi-task chairs**



DIRECT CONNECTING

**CML - 129**

600W x 675D x 910H 450SH mm.



DIRECT CONNECTING

**CML - 139**

605W x 680D x 830H 480SH mm.



**CDO - 600**

455W x 720D x 748H 430SH mm.

**CDO - 600 N**

455W x 720D x 730H 430SH mm.



**CDL - 600**

455W x 720D x 750H 430SH mm.

**CDL - 600 N**

455W x 720D x 730H 430SH mm.



**M5N - L**

625W x 690D x 815H 470SH mm.



**XL - 110**

560W x 705D x 780H 450SH mm.

**Testing and controlling**

Product testing according to JIS, and TIS.

All chairs are strictly tested and controlled according to the Japanese Industrial Standard (JIS), and Thai Industrial Standard (TIS), with the following main testing items :

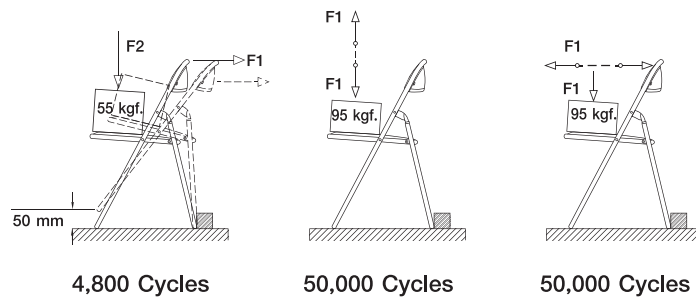

## Hand carts



**CMC - 200**  
650W x 915D x 1145H mm.  
CM - 128, 129, 138, 139  
CML - 129, 139  
M5N - SERIES



**CMC - 300**  
595W x 675D x 1190H mm.  
CM - 001, 004, 012, 013, 014, 015,  
016, 018, 019, 029, 019 N,  
CMO - 004, CMO - 081



**CMC - 1800 N**  
810W x 1625D x 1075H mm.  
FOR MODEL  
TFR - SERIES



**CSC - 300**  
515W x 820D x 1110H mm.  
LTS - SERIES, SCL - SERIES  
CM - 050, XL SERIES

## Educational special sets

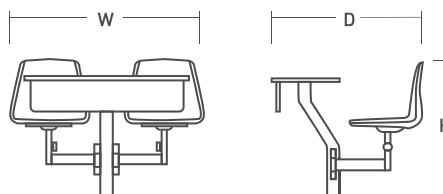

**TAB - 100**  
1100W x 840D x 785H 440SH mm.



## Educational special sets



**TCL - 300**

1100W x 800D x 720H 420SH mm.



**TCL - 300 N**

1100W x 800D x 720H 420SH mm.

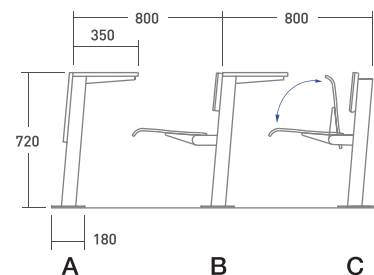

A : FRONT DESK  
B : MIDDLE DESK & CHAIR  
C : REAR CHAIR



**TC - 9702**

400W x 600D x 730H mm.



**CC - 9702**

400W x 445D x 760H 450SH mm.

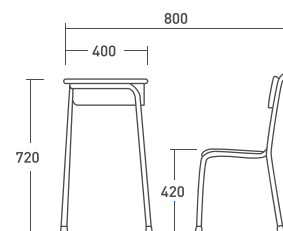

## 7 Level height adjustment educational set



**YM - 02**

400W x 600D x 585H mm.

**YC - 02**

360W x 465D x 690H 360SH mm.

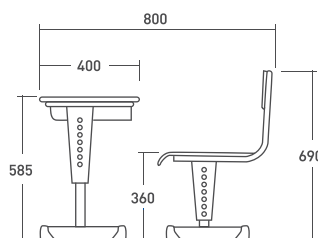

MARK	HEIGHT		
	YC-02 (H)	YC-02 (SH) (H)	
A	765	480	810
B	735	460	790
C	705	440	770
D	675	420	750
E	645	400	730
F	615	380	710
G	585	360	690

## Lecture chairs



**CLO - 812**

1170W x 710D x 790H 440SH mm.



**CLO - 813**

1790W x 710D x 790H 440SH mm.



**MTN - 302 L N13**

1230W x 680D x 750H 450SH mm.



**MTN - 303 L N13**

1805W x 680D x 750H 450SH mm.



**CRP - 352 L**

1320W x 565D x 720H 465SH mm.



**CRP - 353 L**

2020W x 565D x 720H 465SH mm.

## Multi-task chairs



**CRP - 352**  
1250W x 550D x 740H 460SH mm.



**CRP - 453**  
1940W x 610D x 880H 530SH mm.



**CLF - 812**  
1035W x 520D x 790H 440SH mm.



**CLF - 813**  
1600W x 520D x 790H 440SH mm.



**CLP - 822**  
1350W x 530D x 735H 430SH mm.



**CLP - 823**  
2025W x 530D x 735H 430SH mm.



## Multi-task chairs



**CLP - 903**

1630W x 570D x 810H 450SH mm.



**CLP - 904**

2210W x 570D x 810H 450SH mm.



**CLP - 903 A**

1512W x 570D x 810H 450SH mm.  
TOP PLATE : 400 x 400 mm.



**CLP - 903 B**

1460W x 570D x 810H 465SH mm.  
TOP PLATE : 400 x 400 mm.



**XL - 102**

1080W x 550D x 815H 460SH mm.



**XL - 103**

1660W x 550D x 815H 460SH mm.

## Multi-task chairs



### XL - 102 A

1470W x 550D x 815H 460SH mm.  
TOP PLATE : 300 x 300 mm.



### XL - 103 C

2055W x 550D x 815H 460SH mm.  
TOP PLATE : 300 x 300 mm.



### MTN - 302 N13

1090W x 550D x 750H 450SH mm.



### MTN - 303 N13

1675W x 550D x 750H 450SH mm.



### MTN - 302 A N13

1485W x 550D x 750H 450SH mm.  
TOP PLATE : 300 x 300 mm.



### MTN - 303 A N13

2070W x 550D x 750H 450SH mm.  
TOP PLATE : 300 x 300 mm.

## Lobby chairs



**LBM - 1120**  
1085W x 660D x 930H 440SH mm.



**LBM - 1121**  
990W x 660D x 930H 440SH mm.



**LBM - 1121 A**  
1470W x 660D x 930H 440SH mm.



**LBL - 1130**  
1760W x 575D x 810H 440SH mm.



**LBL - 1131**  
1685W x 575D x 810H 440SH mm.



**LBL - 1131 C**  
2020W x 575D x 810H 440SH mm.



## Lobby chairs



**FCL - 103**  
1340W x 410D x 420SH mm.



**FCL - 104**  
1815W x 410D x 420SH mm.



**FCL - 105**  
2300W x 410D x 420SH mm.

## Fast food seatings



**FTM - 200**

1700W x 600D x 760H 440SH mm.



**FTM - 400**

1700W x 1200D x 760H 440SH mm.



**FMB - 04**

1800W x 1200D x 820H 440SH mm.



**FMB - 02**

1000W x 900D x 820H 440SH mm.

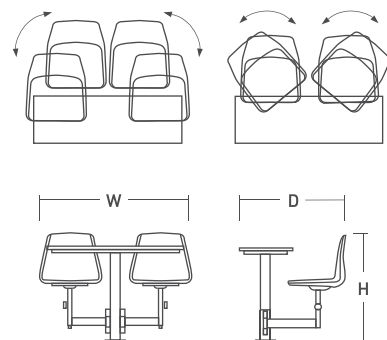

**FMS - 04**

1800W x 1200D x 800H 440SH mm.



**FMS - 02**

1000W x 900D x 800H 440SH mm.

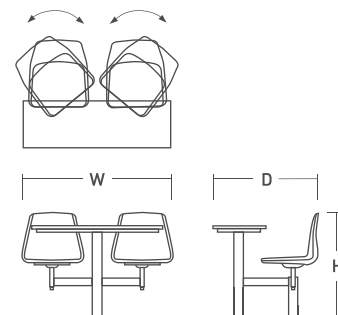

## Theater / Auditorium seatings

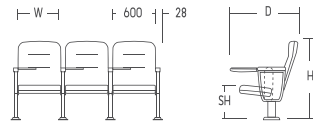

**ADT - 690 PBL** ③

670W x 900D x 1030H 440SH mm.

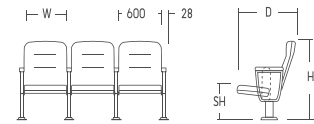

**ADT - 690 PBS** ③

670W x 900D x 1030H 440SH mm.

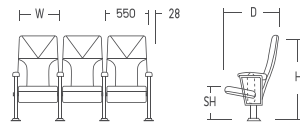

**ADT - 300 PBS** ③

606W x 680D x 1100H 440SH mm.

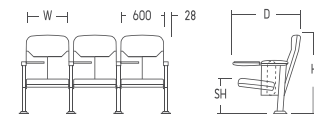

**ADT - 250 EX** ③

655W x 760D x 940H 440SH mm.

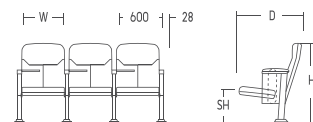

**ADT - 250 EXL**

660W x 850D x 940H 440SH mm.



**CL - 522 L**

600W x 630D x 900H 440SH mm.

## Theater / Auditorium seatings

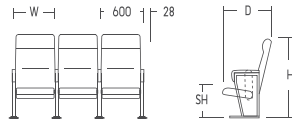

**CL - 422** ③

650W x 760D x 930H 460SH mm.

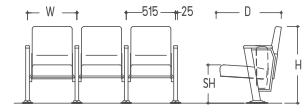

**CL - 920** ③

565W x 640D x 830H 440SH mm.

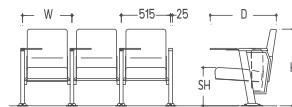

**CL - 920 L** ③

565W x 690D x 830H 440SH mm.

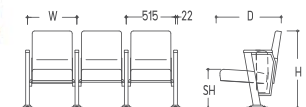

**CL - 921** ③

560W x 640D x 930H 440SH mm.

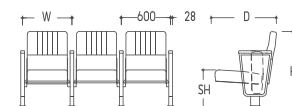

**CL - 918** ③

670W x 670D x 1000H 440SH mm.

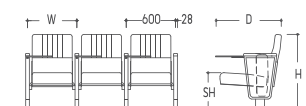

**CL - 918 L** ③

670W x 900D x 1000H 440SH mm.

## Theater / Auditorium seatings

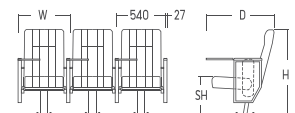

**CL - 915**

554W x 750D x 965H 440SH mm.

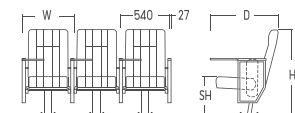

**CL - 915 L**

580W x 810D x 965H 440SH mm.

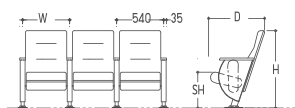

**CL - 930**

600W x 760D x 950H 440SH mm.

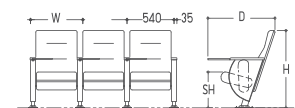

**CL - 930 L**

610W x 850D x 950H 440SH mm.

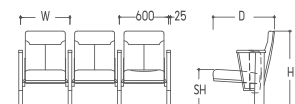

**CL - 940**

660W x 760D x 1000H 440SH mm.

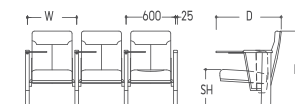

**CL - 940 L**

660W x 770D x 1000H 440SH mm.

## Living chairs



**SF - 801**  
840W x 750D x 670H 400SH mm.



**CLE - 911**  
955W x 760D x 820H 400SH mm.



**SF - 802**  
1320W x 750D x 670H 400SH mm.



**CLE - 912**  
1550W x 760D x 820H 400SH mm.



**SF - 803**  
2040W x 750D x 670H 400SH mm.



**CLE - 913**  
2170W x 760D x 820H 400SH mm.



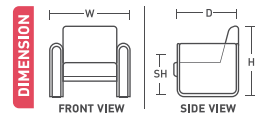

**CLE - 711**  
975W x 755D x 860H 440SH mm.



**CM - 8410**  
685W x 720D x 720H 410SH mm.



**CLE - 712**  
1530W x 755D x 860H 440SH mm.



**CM - 8420**  
1310W x 720D x 720H 410SH mm.



**CLE - 713**  
2110W x 755D x 860H 440SH mm.



**CM - 8430**  
1940W x 720D x 720H 410SH mm.

## Living chairs & Tables



**TJ - 2442 G**  
535W x 1040D x 420H mm.



**TJ - 2424 G**  
535W x 640D x 420H mm.



**TMK - 2424 G**  
610W x 610D x 420H mm.



**TMK - 2442 G**  
610W x 1065D x 420H mm.



**TMW - 2424 G**  
600W x 600D x 420H mm.



**TMW - 2442 G**  
600W x 1060D x 420H mm.



**TMS - G 1**  
385W x 385D x 320H mm.



**TMS - G 2**  
475W x 475D x 370H mm.



**TMS - G 3**  
565W x 565D x 410H mm.

## Fabrics colors for chairs

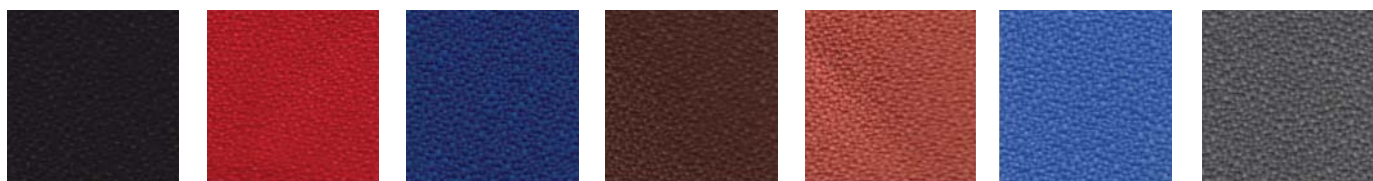

F7 Black / I 12    F7 Scarlet / I 3    F7 Cobalt / 463    F7 Brown / I 31    F7 Blush / 478    F7 Marina / 461    F7 Atomic / 464



F7 Mandarin / 467    F7 Jade / 466    F7 Oatmeal / I 30    F7 Cloud Cream / I 32    F7 Mulberry / I 13    F7 Sunflower / I 33    F7 Pistachio / 427

## Vinyls colors for chairs

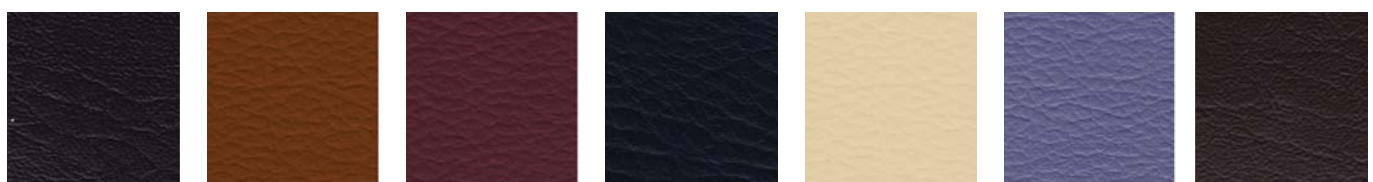

CODE V1-BK / 620    CODE V2-LB / 727    CODE V2-VR / 737    CODE V1-BL / 610    CODE V2-LY / 728    CODE V2-VG / 738    CODE V1-BR / 650



CODE V2-BV / 729    CODE V1-GN / 670    CODE V1-LG / 611    CODE V2-RE / 732    CODE V1-GR / 660

## Polypropylenes colors

### CM - 033, 034

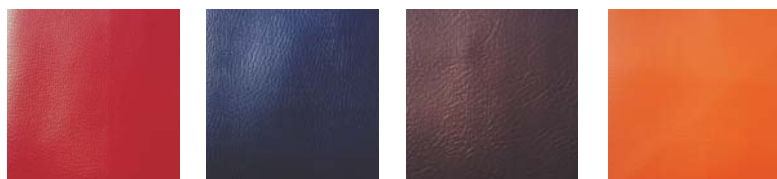

RED V1-RE / 600    BLUE V1-BL / 610    BROWN V1-BR / 650    ORANGE V1-OR / 671

### CM - 081, 083, CLO, KLO, CLF, KLF, FMB, FMS, TAB



RED 500    BLUE 510    ORANGE 520    CREAM 530    DARK BROWN 550    GREEN 570    SKY BLUE 571

### CM - 082, CLP - 822, 823



LIGHT BROWN 540

# PARTITION

Creating a new style of privacy work space with prefabricated partition for a modern office, the office space shall look more panoramas with color matching to the color of furniture, floor and carpet. There are several standard sizes and various styles for selection both straight and curve for more elegance, e.g., panel wall, glass panel, window & door types with preinstalled electrical wiring system and sockets that shall be concealed for the most stylish, easy to remove and reinstall for quickly setting up individual office space. It shall create good atmosphere of private office that leads to highest working efficiency.

Besides, there are other accessories to enhance efficiency of works such as hanging cabinet, hanging shelf and hanging table top for easy movement during working and space saving.





## PARTITION

### PARTITION

สร้างรูปลักษณ์ใหม่ของความเป็นส่วนตัวในการทำงาน ด้วยฉากกั้นห้องสำเร็จรูปสำหรับสำนักงานทันสมัย มีหลากหลายสี สันสวยงามเข้ากับชุดเฟอร์นิเจอร์และพื้นพรม มีขนาดมาตรฐานให้เลือกหลายระดับตามลักษณะการใช้งาน และมีรูปแบบให้เลือกสรรทั้งแบบตรงและแบบโค้ง เพื่อเพิ่มความสวยงาม อาทิ ผนังทึบ ผนังกระจก ประตูหน้าต่างสำเร็จรูป พร้อมระบบสายไฟ และปลั๊กไฟในตัวที่เก็บซ่อนสายไฟได้เพื่อความสะอาด สวยงาม เคลื่อนย้ายปรับเปลี่ยนรูปแบบได้ง่าย จึงกั้นภายในสำนักงานเป็นห้อง แยกเป็นสัดส่วนได้อย่างดี สร้างเสริมบรรยากาศเฉพาะตัวในการทำงาน อันส่งผลให้เกิดประสิทธิภาพสูงสุดในการบริหารงานอีกด้วย

นอกจากนั้น ยังมีอุปกรณ์เสริมอำนวยความสะดวกครบครัน เช่น ตู้แขวน ชั้นแขวน แผ่นหน้าโต๊ะแขวน เพื่อความคล่องตัวในการทำงานและประหยัดพื้นที่

Creating a new style of privacy work space with prefabricated partition for a modern office, the office space shall look more panoramas with color matching to the color of furniture, floor and carpet. There are several standard sizes and various styles for selection both straight and curve for more elegance, e.g., panel wall, glass panel, window & door types with preinstalled electrical wiring system and sockets that shall be concealed for the most stylish, easy to remove and reinstall for quickly setting up individual office space. It shall create good atmosphere of private office that leads to highest working efficiency.

Besides, there are other accessories to enhance efficiency of works such as hanging cabinet, hanging shelf and hanging table top for easy movement during working and space saving.



# PARTITION



## Work with team

**Create high partition to set privacy area for team workstation**

- For 3 persons Top surface 750X x 600D x 1400W
- 3-Drawer mobile pedestal
- 3-Sliding door overhead cabinet



## Design your space

**Create your space for unlock your potential  
create your style and function from working behavior  
work studio for 4 persons**



# Feature & Benefit



End cap



3-Way pole connector



Single leg



Hanging shelf



Sliding door over head cabinet



# N8 PANEL SYSTEM PARTITIONS

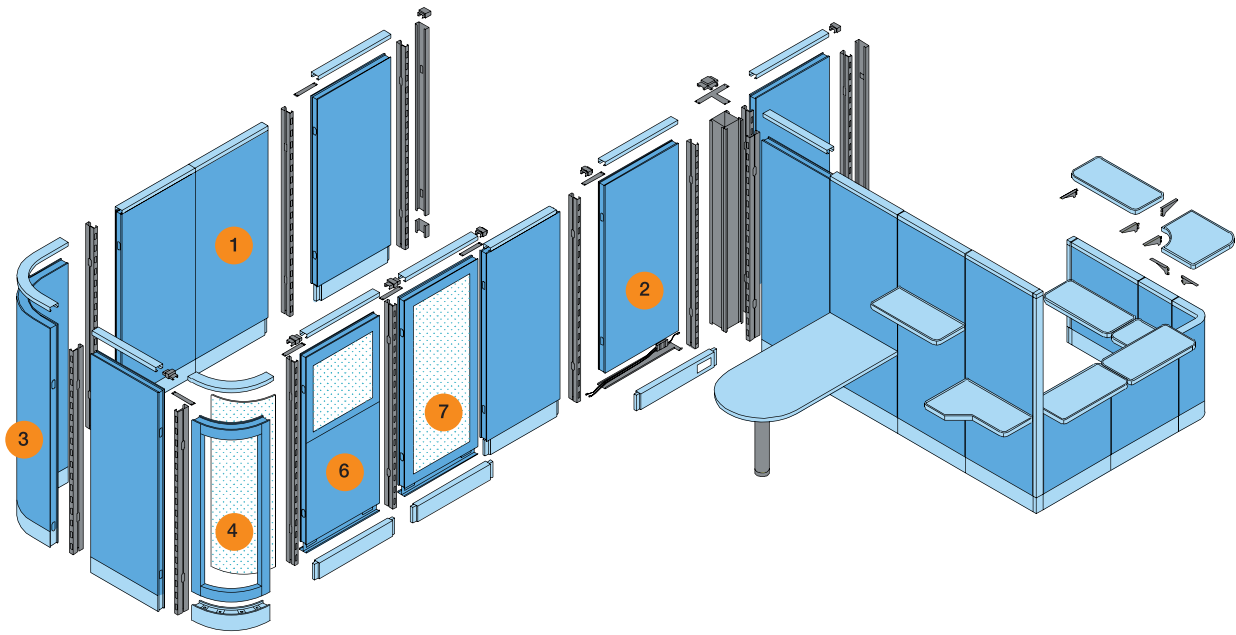

**1. STRAIGHT PANELS**  
(INCLUDING TOP & BASE)

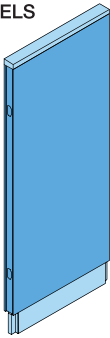

**2. PANELS WITH AC OUTLETS IN BASE (ONE SIDE)**

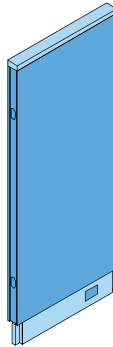

**2. PANELS WITH AC OUTLETS IN BASE (BOTH SIDE)**

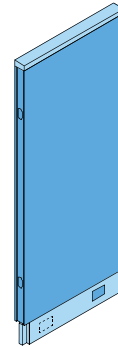

MODEL	SIZE	
	H	W
N8 311X	1000	450
N8 312X		600
N8 313X		700
N8 314X		800
N8 315X		900
N8 316X		1000
N8 317X		1200
N8 3E1X	1100	450
N8 3E2X		600
N8 3E3X		700
N8 3E4X		800
N8 3E5X		900
N8 3E6X		1000
N8 3E7X		1200
N8 321X	1200	450
N8 322X		600
N8 323X		700
N8 324X		800
N8 325X		900
N8 326X		1000
N8 327X		1200
N8 331X	1400	450
N8 332X		600
N8 333X		700
N8 334X		800
N8 335X		900
N8 336X		1000
N8 337X		1200

MODEL	SIZE	
	H	W
N8 341X	1600	450
N8 342X		600
N8 343X		700
N8 344X		800
N8 345X		900
N8 346X		1000
N8 347X		1200
N8 351X	1800	450
N8 352X		600
N8 353X		700
N8 354X		800
N8 355X		900
N8 356X		1000
N8 357X		1200
N8 361X	2000	450
N8 362X		600
N8 363X		700
N8 364X		800
N8 365X		900
N8 366X		1000
N8 367X		1200

MODEL		SIZE	
ONE SIDE	BOTH SIDE	H	W
N8 C15C	N8 D15D	1000	900
N8 C16C	N8 D16D		1000
N8 C17C	N8 D17D		1200
N8 CE5C	N8 DE5D	1100	900
N8 CE6C	N8 DE6D		1000
N8 CE7C	N8 DE7D		1200
N8 C25C	N8 D25D	1200	900
N8 C26C	N8 D26D		1000
N8 C27C	N8 D27D		1200
N8 C35C	N8 D35D	1400	900
N8 C36C	N8 D36D		1000
N8 C37C	N8 D37D		1200
N8 C45C	N8 D45D	1600	900
N8 C46C	N8 D46D		1000
N8 C47C	N8 D47D		1200
N8 C55C	N8 D55D	1800	900
N8 C56C	N8 D56D		1000
N8 C57C	N8 D57D		1200
N8 C65C	N8 D65D	2000	900
N8 C66C	N8 D66D		1000
N8 C67C	N8 D67D		1200

# N8 PANEL SYSTEM PARTITIONS

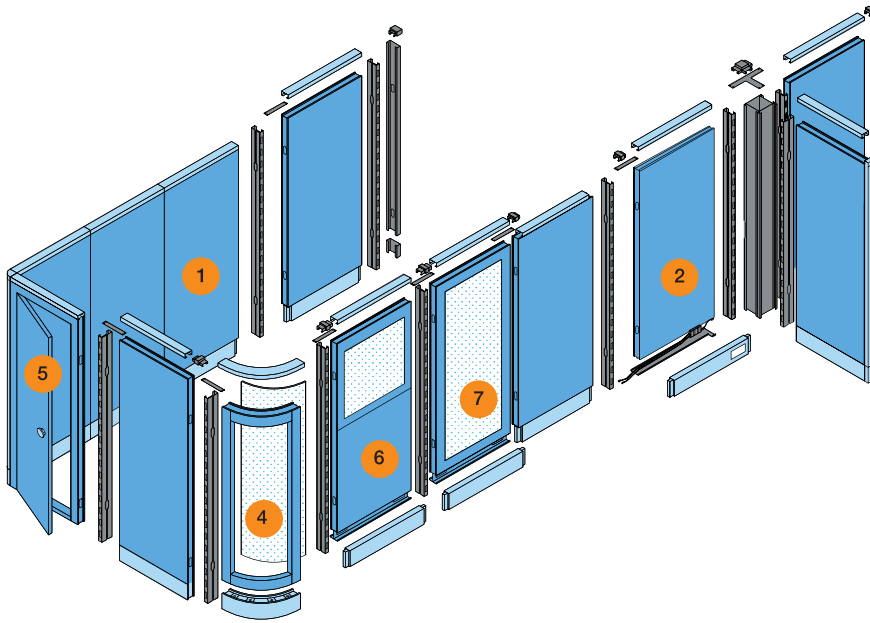
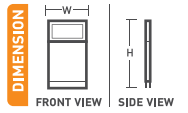

## 4. GLASS CURVED PANELS (ALUMINIUM FRAMES) (INCLUDING TOP & BASE)

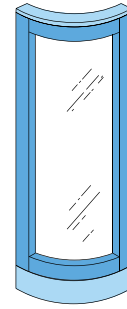

MODEL	SIZE	
	H	W
N8 T20X	1200	450
N8 T30X	1400	
N8 T40X	1600	
N8 T50X	1800	
N8 T60X	2000	

## 3. CURVED PANELS (INCLUDING TOP & BASE)

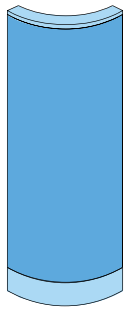

MODEL	SIZE	
	H	W
N8 310X	1000	450
N8 3E0X	1100	
N8 320X	1200	
N8 330X	1400	
N8 340X	1600	
N8 350X	1800	
N8 360X	2000	

## 6. GLASS COMPOSITE PANELS (INCLUDING TOP CAP & BASE)

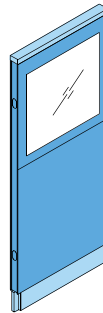

MODEL	SIZE	
	H	W
N8 G32X	1400	600
N8 G34X		800
N8 G35X		900
N8 G36X	1600	1000
N8 G37X		1200
N8 G42X		600
N8 G44X	1800	800
N8 G45X		900
N8 G46X		1000
N8 G47X	2000	1200
N8 G52X		600
N8 G54X		800
N8 G55X	1800	900
N8 G56X		1000
N8 G57X		1200
N8 G62X	2000	600
N8 G64X		800
N8 G65X		900
N8 G66X	1800	1000
N8 G67X		1200

## 7. GLASS PANELS (ALUMINIUM FRAMES) (INCLUDING TOP CAP & BASE)

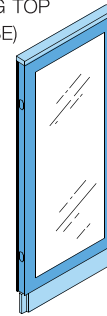

MODEL	SIZE	
	H	W
N8 T22X	1200	600
N8 T23X		700
N8 T24X		800
N8 T25X		900
N8 T26X	1400	1000
N8 T27X		1200
N8 T32X		600
N8 T33X		700
N8 T34X	1600	800
N8 T35X		900
N8 T36X		1000
N8 T37X		1200
N8 T42X	1800	600
N8 T43X		700
N8 T44X		800
N8 T45X		900
N8 T46X	2000	1000
N8 T47X		1200
N8 T52X		600
N8 T53X		700
N8 T64X	1800	800
N8 T65X		900
N8 T66X		1000
N8 T67X		1200

## 5. DOOR PANELS

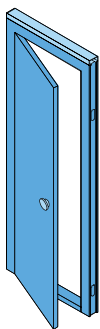

MODEL	SIZE	
	H	W
N8 383X	2000	900

## N8 Panel system partitions

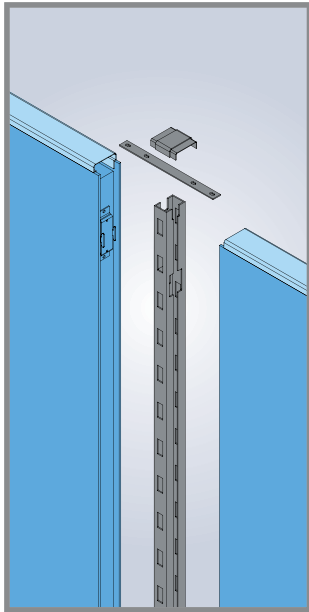

UPRIGHT

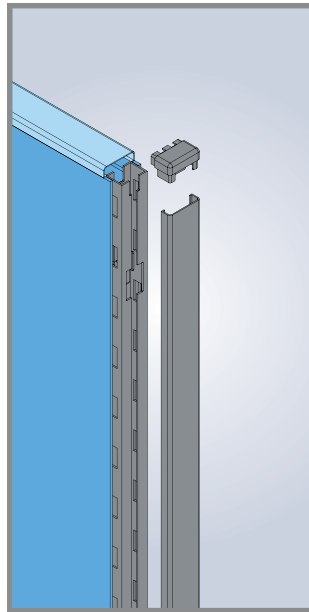

UPRIGHT COVER

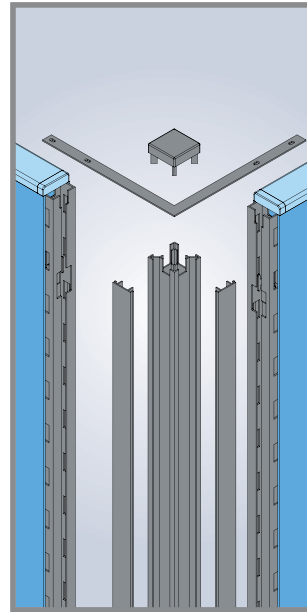

90° CORNER

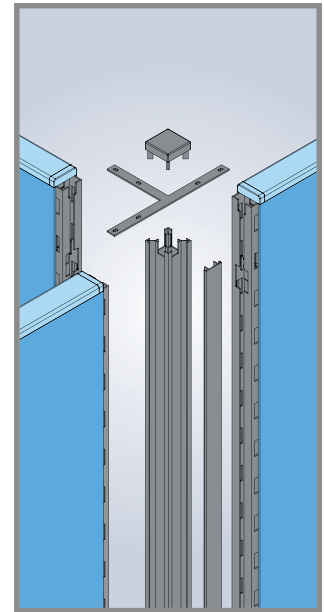

T JOINT

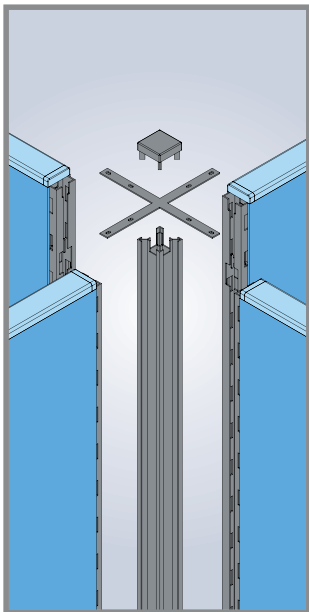

+ JOINT

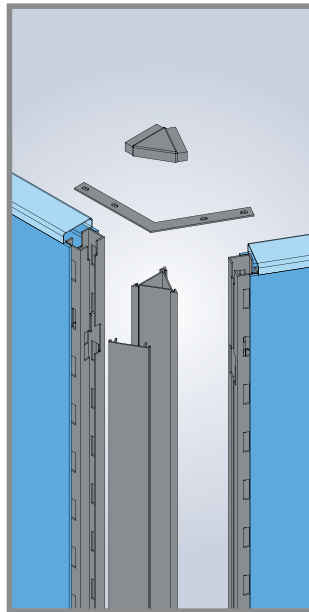

135° CORNER

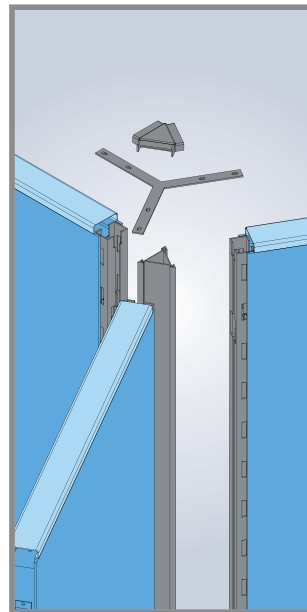

3 WAY 120°

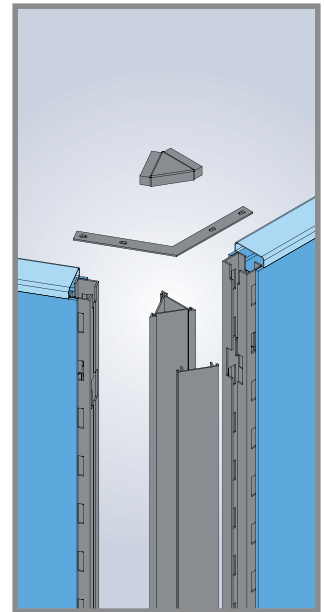

120° JOINT SET

UPRIGHT	UPRIGHT COVER	90° CORNER	T JOINT	+ JOINT	135° CORNER	3 WAY 120°	120° JOINT SET	H (mm.)
N8 811Y	N8 812Y	N8 813Y	N8 814Y	N8 815Y	N8 816Y	N8 817Y	N8 818Y	1000
N8 8E1Y	N8 8E2Y	N8 8E3Y	N8 8E4Y	N8 8E5Y	N8 8E6Y	N8 8E7Y	N8 8E8Y	1100
N8 821Y	N8 822Y	N8 823Y	N8 824Y	N8 825Y	N8 826Y	N8 827Y	N8 828Y	1200
N8 831Y	N8 832Y	N8 833Y	N8 834Y	N8 835Y	N8 836Y	N8 837Y	N8 838Y	1400
N8 841Y	N8 842Y	N8 843Y	N8 844Y	N8 845Y	N8 846Y	N8 847Y	N8 848Y	1600
N8 851Y	N8 852Y	N8 853Y	N8 854Y	N8 855Y	N8 856Y	N8 857Y	N8 858Y	1800
N8 861Y	N8 862Y	N8 863Y	N8 864Y	N8 865Y	N8 866Y	N8 867Y	N8 868Y	2000

# Different height joints

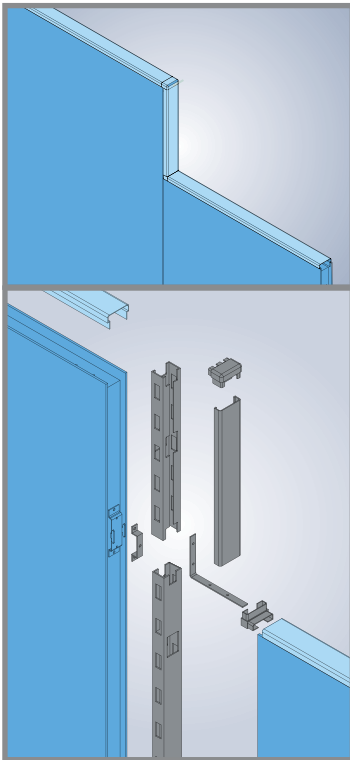

STRAIGHT

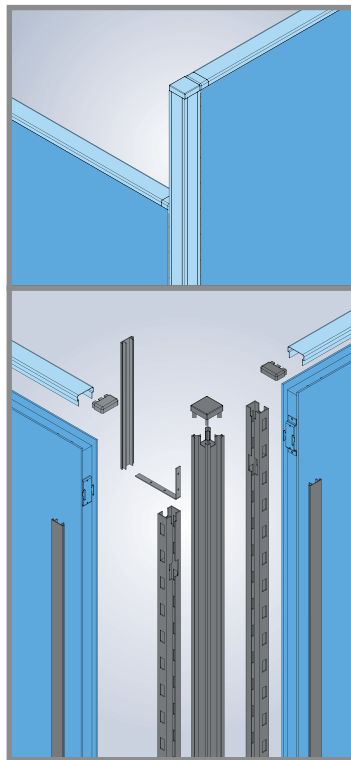

90° LEFT RIGHT CORNER

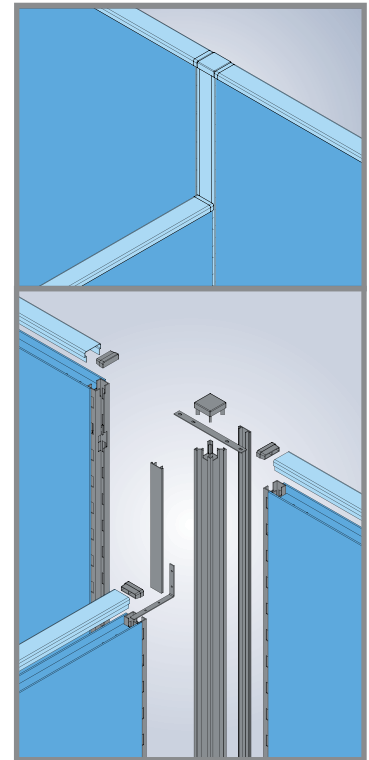

"T" TYPE CORNER PIECE (A)

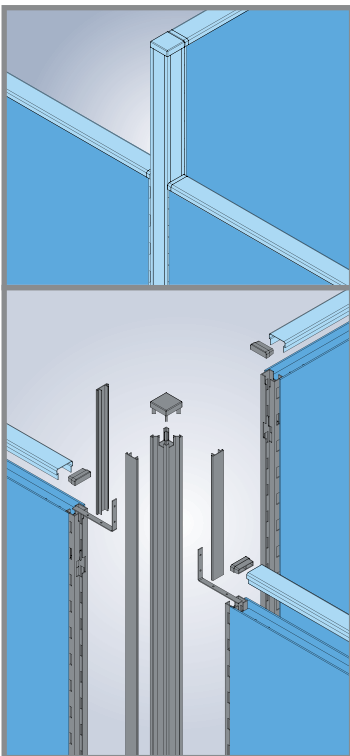

"T" TYPE CORNER PIECE (B)

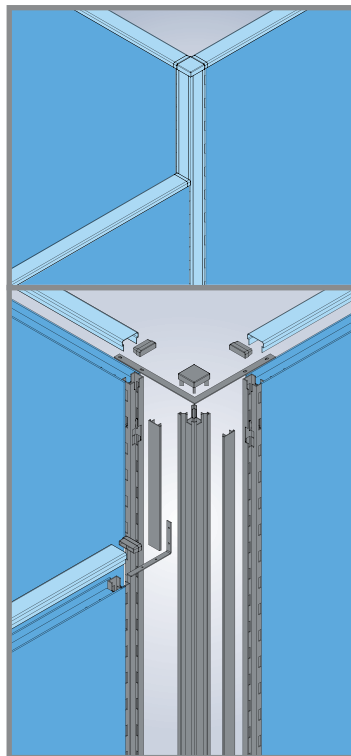

"T" TYPE CORNER PIECE (C)

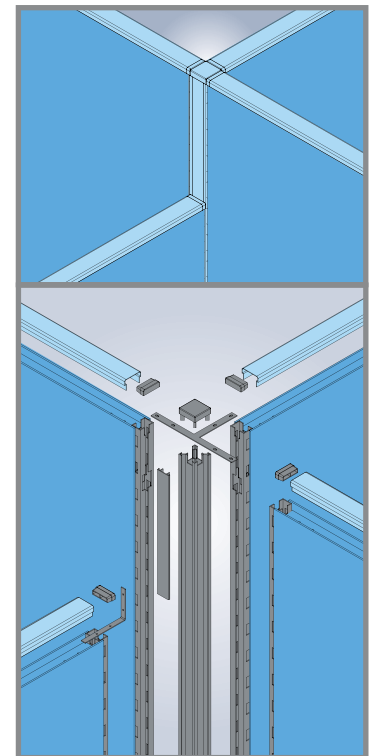

"+" TYPE CORNER PIECE (A)

# N8 PANEL SYSTEM PARTITIONS

## Different height joints

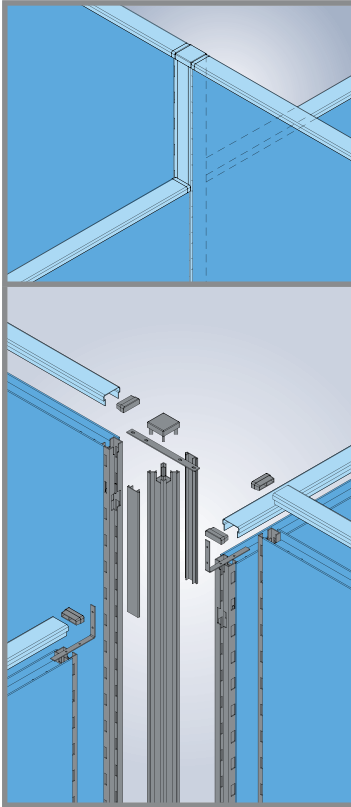

"+" TYPE CORNER PIECE (B)

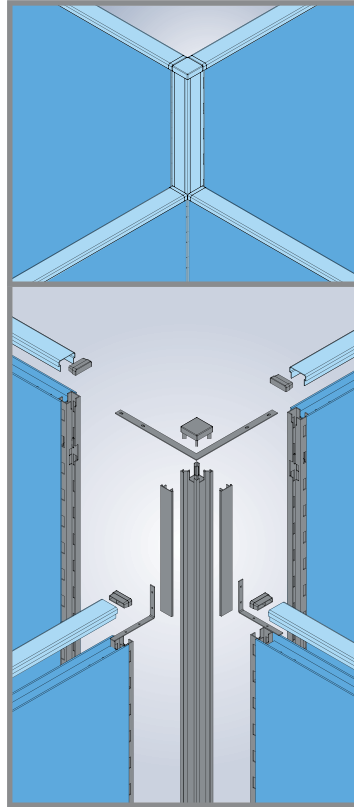

"+" TYPE CORNER PIECE (C)

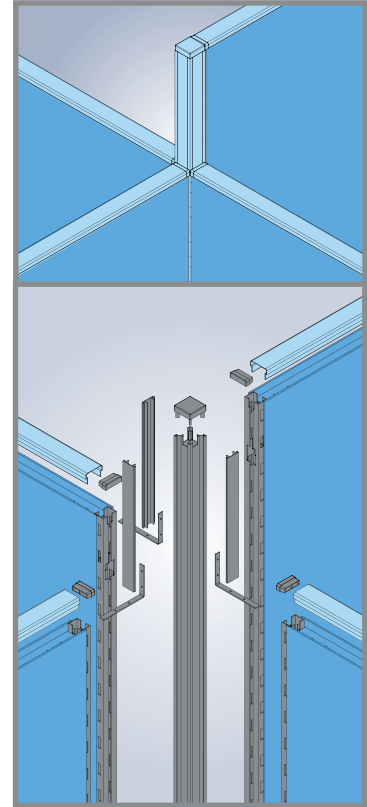

"+" TYPE CORNER PIECE (D)

MODEL STRAIGHT	90° LEFT - RIGHT CORNER PIECES	CORNER PIECES								H (mm.)
		"T" TYPE			"+" TYPE					
		(A)	(B)	(C)	(A)	(B)	(C)	(D)		
N8 FF1Y	"N8 GF1L, GF1R"	N8 HF1Y	N8 EF1Y	N8 JF1Y	N8 KF1Y	N8 LF1Y	N8 MF1Y	N8 NF1Y	100	
N8 FG1Y	"N8 GG1L, GG1R"	N8 HG1Y	N8 EG1Y	N8 JG1Y	N8 KG1Y	N8 LG1Y	N8 MG1Y	N8 NG1Y	100	
N8 F21Y	N8 G21L (R)	N8 H21Y	N8 E21Y	N8 J21Y	N8 K21Y	N8 L21Y	N8 M21Y	N8 N21Y	200	
N8 F31Y	N8 G31L (R)	N8 H31Y	N8 E31Y	N8 J31Y	N8 K31Y	N8 L31Y	N8 M31Y	N8 N31Y	300	
N8 F41Y	N8 G41L (R)	N8 H41Y	N8 E41Y	N8 J41Y	N8 K41Y	N8 L41Y	N8 M41Y	N8 N41Y	400	
N8 F51Y	N8 G51L (R)	N8 H51Y	N8 E51Y	N8 J51Y	N8 K51Y	N8 L51Y	N8 M51Y	N8 N51Y	500	
N8 F61Y	N8 G61L (R)	N8 H61Y	N8 E61Y	N8 J61Y	N8 K61Y	N8 L61Y	N8 M61Y	N8 N61Y	600	
N8 F71Y	N8 G71L (R)	N8 H71Y	N8 E71Y	N8 J71Y	N8 K71Y	N8 L71Y	N8 M71Y	N8 N71Y	700	
N8 F81Y	N8 G81L (R)	N8 H81Y	N8 E81Y	N8 J81Y	N8 K81Y	N8 L81Y	N8 M81Y	N8 N81Y	800	
N8 F91Y	N8 G91L (R)	N8 H91Y	N8 E91Y	N8 J91Y	N8 K91Y	N8 L91Y	N8 M91Y	N8 N91Y	900	
N8 F01Y	N8 G01L (R)	N8 H01Y	N8 E01Y	N8 J01Y	N8 K01Y	N8 L01Y	N8 M01Y	N8 N01Y	1000	



# ACCESSORIES PARTITIONS

WORK TOPS, SOFT EDGE TYPE			
	MODEL	SIZE(mm.)	
		D	W
	N8 651Y	450	900
	N8 653Y		1000
	N8 652Y		1200
	N8 655Y		1800
	N8 676M	600	600
	N8 677M		700
	N8 678M		800
	N8 671M		900
	N8 673M		1000
	N8 672M		1200
	N8 675M	1800	
	N8 S06Y	700	600
N8 S07Y	700		
N8 S08Y	800		
N8 S09Y	900		
N8 S10Y	1000		
N8 S12Y	1200		
	N8 625Y	450	1800
	N8 627Y		1900
	N8 626Y		2100
	N8 633Y	450	1350
	N8 635Y		1450
	N8 634Y		1650
	N8 643Y	450	1350
	N8 645Y		1450
	N8 644Y		1650
	N8 661Y	450	900
	N8 663Y		1000
	N8 662Y		1200
	N8 665Y		1800
	N8 S62R	700	1200
	N8 S64R		1400
	N8 S62L		1200
	N8 S64L		1400

CORNER WORK TOPS, SOFT EDGE TYPE			
	MODEL	SIZE(mm.)	
		W	D
	N8 751R	900	600
	N8 753R	900	700
	N8 755R	1200	600
	N8 754R	1200	700
	N8 761R	900	600
	N8 763R	900	700
	N8 762R	1200	600
	N8 764R	1200	700
	N8 660Y	R	450

WORK TOPS, SOFT EDGE TYPE WITH WIRE ACCESS			
	MODEL	SIZE(mm.)	
		W	D
	N8 061Y	900	600
	N8 062Y	1200	
	N8 063Y	1000	

MEETING TABLES, SOFT EDGE TYPES			
	MODEL	SIZE(mm.)	
		W	D
	N8 S41Y	1200	700
	N8 S44Y	1200	800
	N8 S42Y	1400	700
	N8 S45Y	1400	800
	N8 S43Y	1600	700
	N8 S46Y	1600	800

# N8 PANEL SYSTEM PARTITIONS

## Different height joints

HANGING SHELVES				
	MODEL	SIZE(mm.)		
		W	D	H
	N8 614Y	800	250	70
	N8 615Y	900		
	N8 616Y	1000		
	N8 617Y	1200		
	N8 620Y	800	250	200
	N8 621Y	900		
	N8 622Y	1000		
	N8 623Y	1200		

HANGING CABINETS				
	MODEL	SIZE(mm.)		
		W	D	H
	N8 680S	800	328	390
	N8 681S	900		
	N8 682S	1000		
	N8 683S	1200		
	N8 680SG	800	328	390
	N8 681SG	900		
	N8 682SG	1000		
	N8 683SG	1200		

## Standard fabric color for partition

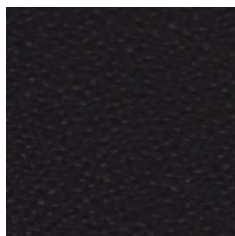

F7 Black / I 12



F7 Scarlet / I 34

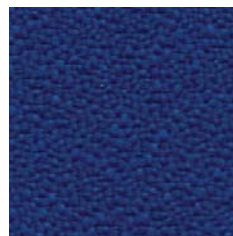

F7 Cobalt / 463

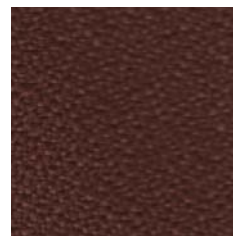

F7 Brown / I 31



F7 Blush / 478

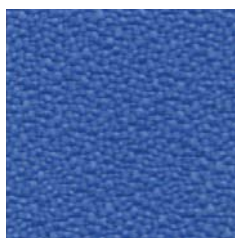

F7 Marina / 461



F7 Atomic / 464

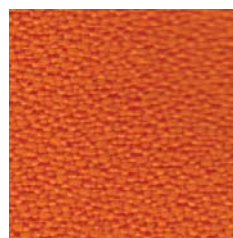

F7 Mandarin / 467

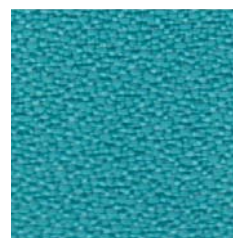

F7 Jade / 466

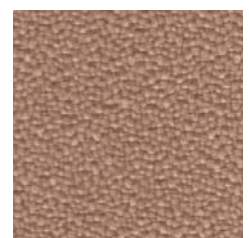

F7 Oatmeal / I 30



F7 Cloud Cream / I 32

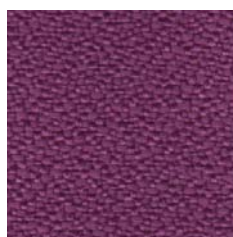

F7 Mulberry / I 13

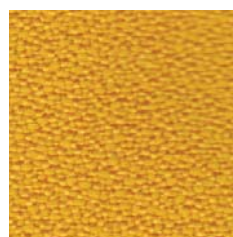

F7 Sunflower / I 33

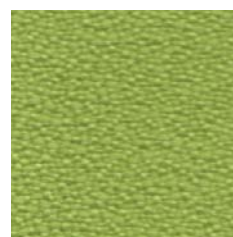

F7 Pistachio / 427

# SAFE

The "KINGDOM" Super Safes protect your valuable properties against both burglary and fire. They are thoroughly designed and manufactured with well selected materials and accessories suitable extra strong with beautiful design. They have ability to stand in fire for more than two hours at temperature of 1850° F (1010° C). "KINGDOM" Super Safes are equipped with key-lock and combination lock which the combination can be changed for about one million number. Moreover, the combination lock shall automatically lock up when it is treated by force. Super Safes have safety system to prevent removing. Thus, it is suitable to use in house and office for protection your valuable properties.



## SAFE SAFE

ตู้নিরภัย “คิงด้อม” ซูเปอร์เซฟ คุ่มครองทรัพย์สินมีค่าของท่านได้อย่างปลอดภัย ทั้งจากการโจรกรรมและอัคคีภัย ออกแบบอย่างพิถีพิถัน ใช้วัสดุอุปกรณ์ที่ผ่านการคัดเลือกมาอย่างดีเยี่ยมว่าเหมาะสมกับการผลิตตู้নিরภัยโดยเฉพาะ ภายใต้การผลิตด้วยเทคโนโลยีอันทันสมัยและควบคุมการผลิตอย่างเคร่งครัด โดยวิศวกรผู้ชำนาญการ จึงแข็งแรงทนทานเป็นเยี่ยม รูปทรงสวยงาม สามารถป้องกันไฟได้นานกว่า 2 ชั่วโมง ที่อุณหภูมิ 1850°F (1010°C) มีกุญแจลิคคพร้อมรหัส ซึ่งสามารถตั้งรหัสได้เองและเปลี่ยนเลขหมายได้กว่าล้านเลขหมาย ระบบรหัสจะลิคคเองโดยอัตโนมัติเมื่อรหัสถูกทำลาย มีระบบป้องกันการเคลื่อนย้าย จึงปกป้องทรัพย์สินได้ดีเยี่ยมเหมาะสำหรับใช้ทั้งในบ้านและสำนักงานต่าง ๆ

The "KINGDOM" Super Safes protect your valuable properties against both burglary and fire. They are thoroughly designed and manufactured with well selected materials and accessories suitable extra strong with beautiful design. They have ability to stand in fire for more than two hours at temperature of 1850 °F (1010 °C). "KINGDOM" Super Safes are equipped with key-lock and combination lock which the combination can be changed for about one million number. Moreover, the combination lock shall automatically lock up when it is treated by force. Super Safes have safety system to prevent removing. Thus, it is suitable to use in house and office for protection your valuable properties.



**Modern compact fire resistant safes**



2H

**SA - 991**

OUTSIDE : 490W x 435D x 390H mm.  
INSIDE : 360W x 335D x 260H mm.



DOOR COLOR  
LIGHT GRAY (#300)



BODY COLOR  
GRAY (#310)



2H

**SA - 992**

OUTSIDE : 390W x 435D x 490H mm.  
INSIDE : 260W x 335D x 360H mm.



2H



**SA - 2011**

OUTSIDE : 550W x 530D x 530H mm.  
INSIDE : 402W x 400D x 384H mm.



DOOR COLOR  
SILVER (#352)



BODY COLOR  
DARK GRAY (#356)



2H



**SA - 2012**

OUTSIDE : 550W x 530D x 788H mm.  
INSIDE : 402W x 400D x 573H mm.



2H



**SA - 2013**

OUTSIDE : 620W x 530D x 1015H mm.  
INSIDE : 474W x 400D x 794H mm.



2H

**ST - 924**

OUTSIDE : 550W x 550D x 700H mm.  
INSIDE : 374W x 374D x 444H mm.



DOOR COLOR  
LIGHT GRAY (#300)



BODY COLOR  
GRAY (#310)



2H

**ST - 923**

OUTSIDE : 550W x 550D x 800H mm.  
INSIDE : 374W x 374D x 544H mm.



2H

**ST - 921**

OUTSIDE : 650W x 620D x 1000H mm.  
INSIDE : 434W x 410D x 710H mm.

## Compact fire resistant safes



**SA - 827**

OUTSIDE : 476W x 400D x 350H mm.  
INSIDE : 350W x 257D x 216H mm.



**SA - 826**

OUTSIDE : 476W x 430D x 491H mm.  
INSIDE : 350W x 297D x 300H mm.



**SA - 825**

OUTSIDE : 528W x 463D x 716H mm.  
INSIDE : 402W x 328D x 512H mm.



**SA - 8252**

OUTSIDE : 528W x 518D x 780H mm.  
INSIDE : 402W x 384D x 576H mm.



DOOR COLOR  
LIGHT GRAY (#300)



BODY COLOR  
GRAY (#310)

## Dignified fire resistant safes



**SA - 824**

OUTSIDE :  
618W x 528D x 1006H mm.  
INSIDE :  
402W x 318D x 720H mm.



**SA - 823**

OUTSIDE :  
716W x 625D x 1330H mm.  
INSIDE :  
500W x 415D x 1047H mm.



**SA - 8232**

OUTSIDE :  
851W x 750D x 1486H mm.  
INSIDE :  
630W x 530D x 1200H mm.



**SA - 821 S**

OUTSIDE :  
716W x 625D x 1816H mm.  
INSIDE :  
500W x 415D x 1526H mm.



DOOR COLOR  
LIGHT GRAY (#300)



BODY COLOR  
GRAY (#310)

\* COLOR MAY NOT BE EXACTLY SHOWN



## Dignified fire resistant safes, 2 - door type



**SA - 822**

OUTSIDE : 1096W x 625D x 1486H mm.  
INSIDE : 900W x 415D x 1200H mm.



DOOR COLOR  
LIGHT GRAY (#300)



BODY COLOR  
GRAY (#310)



**SA - 821**

OUTSIDE : 1096W x 625D x 1816H mm.  
INSIDE : 900W x 415D x 1526H mm.

## Burglary resistant safes



**SA - 2024**

OUTSIDE : 500W x 500D x 600H mm.  
INSIDE : 370W x 350D x 470H mm.



**SA - 2428**

OUTSIDE : 600W x 500D x 700H mm.  
INSIDE : 470W x 350D x 570H mm.



**SA - 2434**

OUTSIDE : 600W x 500D x 850H mm.  
INSIDE : 470W x 350D x 720H mm.



**SA - 2962**

OUTSIDE : 740W x 870D x 1560H mm.  
INSIDE : 550W x 700D x 1370H mm.



BODY AND DOOR COLOR  
SEMI GRAY (#151)



**SA - 4735**

OUTSIDE : 475W x 400D x 350H mm.  
INSIDE : 375W x 275D x 250H mm.

## Day - night fire resistant deposit safes

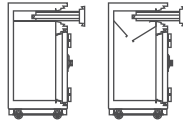

**SAD - 2012**

OUTSIDE : 548W x 530D x 788H mm.  
INSIDE : 402W x 400D x 573H mm.

**SAN - 2012**

OUTSIDE : 548W x 530D x 788H mm.  
INSIDE : 402W x 400D x 573H mm.



DOOR COLOR  
SILVER (#352)



BODY COLOR  
DARK GRAY (#356)

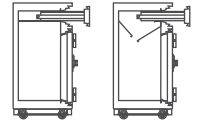

**SAD - 8253**

OUTSIDE : 528W x 463D x 900H mm.  
INSIDE : 402W x 328D x 695H mm.

**SAN - 8253**

OUTSIDE : 528W x 463D x 900H mm.  
INSIDE : 402W x 328D x 695H mm.



DOOR COLOR  
LIGHT GRAY (#300)



BODY COLOR  
GRAY (#310)

## Fire resistant data safes



**DAS - 2012**

OUTSIDE : 548W x 530D x 788H mm.  
INSIDE : 360W x 346D x 532H mm.



BODY & DOOR COLOR  
SILVER (#352)



**DAS - 9701**

OUTSIDE : 850W x 750D x 1486H mm.  
INSIDE : 480W x 370D x 1050H mm.

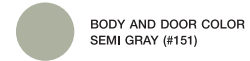

BODY AND DOOR COLOR  
SEMI GRAY (#151)

## Gun & Pistol safes



**GPS - 036** OUTSIDE : 350W x 390D x 1450H mm.  
INSIDE : 345W x 310D x 1256H mm.



DOOR COLOR  
SILVER (#352)



BODY COLOR  
DARK GRAY (#356)



**GPS - F 0316** OUTSIDE : 653W x 594D x 1720H mm.  
INSIDE : 523W x 424D x 1469H mm.

**GPS - 0316** OUTSIDE : 675W x 390D x 1600H mm.  
INSIDE : 670W x 310D x 1406H mm.

**GPS - 0313** OUTSIDE : 533W x 533D x 1600H mm.  
INSIDE : 517W x 417D x 1406H mm.

\* COLOR MAY NOT BE EXACTLY SHOWN

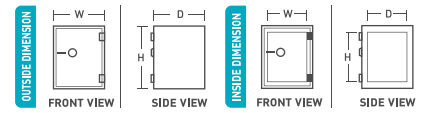

## Burglary resistant doors



**SA - 2130**

OUTSIDE : 1163W x 127D x 2145H mm.  
INSIDE : 905W x 127D x 2005H mm.



DOOR COLOR  
LIGHT GRAY (#300)



BODY COLOR  
GRAY (#310)



**SA - 2130 S**

OUTSIDE : 1163W x 127D x 2145H mm.  
INSIDE : 905W x 127D x 2005H mm.

## Fire resistant drawer safes



**SA - 702**

OUTSIDE : 514W x 756D x 830H mm.  
INSIDE : 433W x 672D x 679H mm.



DOOR COLOR  
LIGHT GRAY (#300)



BODY COLOR  
GRAY (#310)



**SA - 703**

OUTSIDE : 514W x 756D x 1186H mm.  
INSIDE : 433W x 672D x 1043H mm.



**SA - 704**

OUTSIDE : 514W x 756D x 1553H mm.  
INSIDE : 433W x 672D x 1403H mm.

\* COLOR MAY NOT BE EXACTLY SHOWN

## Electronic safe



2H

### SAE - 991N

OUTSIDE : 490W x 435D x 390H mm.  
INSIDE : 360W x 335D x 260H mm.



2H

### SAE - 992N

OUTSIDE : 390W x 435D x 490H mm.  
INSIDE : 260W x 335D x 360H mm.



2H

### SAE - 112N

OUTSIDE : 445W x 425D x 475H mm.  
INSIDE : 323W x 300D x 353H mm.



2H

### SAE - 8263

OUTSIDE : 426W x 430D x 476H mm.  
INSIDE : 300W x 300D x 350H mm.



2H

### SAE - 826

OUTSIDE : 476W x 430D x 491H mm.  
INSIDE : 350W x 297D x 300H mm.



2H

### SAE - 8262

OUTSIDE : 476W x 430D x 597H mm.  
INSIDE : 350W x 297D x 391H mm.



2H

### SAE - 825

OUTSIDE : 528W x 463D x 716H mm.  
INSIDE : 402W x 328D x 512H mm.



2H

### SAE - 2012

OUTSIDE : 548W x 530D x 788H mm.  
INSIDE : 402W x 400D x 573H mm.



2H

### SAE - 2013

OUTSIDE : 620W x 530D x 1008H mm.  
INSIDE : 474W x 400D x 794H mm.



DOOR COLOR  
SILVER (#352)



BODY COLOR  
DARK BLUE (#348)



BODY AND DOOR COLOR  
BLACK (#359)

\* COLOR MAY NOT BE EXACTLY SHOWN

# SHELVES

"Lucky" multi-purpose shelves are not only durable but also beautiful. They have variety of designs for various uses and aspects of work required such as supermarket shelves, book shelves, storage shelves, etc. Suitable to use in several places such as office, library, supermarket, factory including home.

okamura





# SHELVES

## SHELVES

ชั้นอเนกประสงค์ของ "ลัคกี้" นอกจากจะมีความแข็งแรงทนทานแล้ว ยังออกแบบให้สวยงาม เหมาะสำหรับใช้ทั้งในสำนักงาน ห้องสมุด ซูเปอร์มาร์เก็ต โรงงาน อุตสาหกรรม รวมทั้งในบ้านพักอาศัย มีให้เลือกมากมายหลายรูปแบบ ตามลักษณะการใช้งาน อาทิ ชั้นซูเปอร์มาร์เก็ต ชั้นวางหนังสือและชั้นเก็บของ เป็นต้น

“Lucky” multi-purpose shelves are not only durable but also beautiful. They have variety of designs for various uses and aspects of work required such as supermarket shelves, book shelves, storage shelves, etc. Suitable to use in several places such as office, library, supermarket, factory including home.

okamura





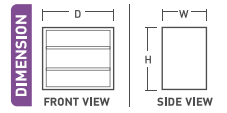

## Library shelves



**S - 317 N**  
925W x 546D x 1969H mm.



**S - 327 N**  
1825W x 546D x 1969H mm.



**S - 504**  
1219W x 305D x 1527H mm.

 BODY COLOR : CREAM (#180)  
COLOR MAY NOT BE EXACTLY SHOWN

## Filing shelves



**S - 666 N**  
921W x 311D x 1805H mm.



**S - 366 N**  
921W x 311D x 962H mm.

 CREAM (#180)  
COLOR MAY NOT BE EXACTLY SHOWN



## Book cases



**SB - 3030**  
762W x 320D x 762H mm.



**SB - 3042**  
762W x 320D x 1067H mm.



**SB - 3048**  
762W x 320D x 1219H mm.



**SB - 3060**  
762W x 320D x 1524H mm.



**SB - 3072**  
762W x 320D x 1829H mm.



**SB - 3078**  
762W x 320D x 1981H mm.

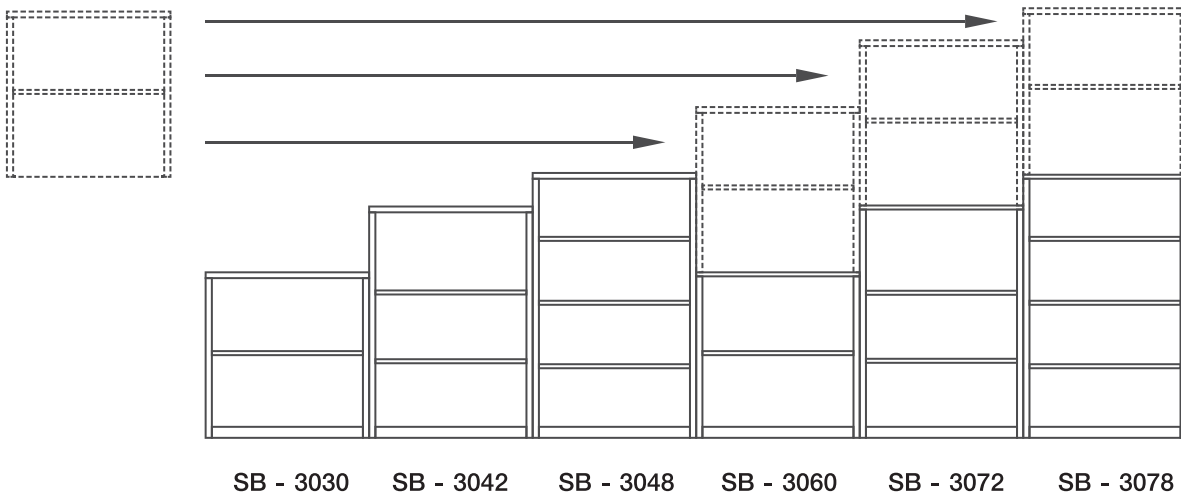

BODY COLOR : CREAM (#180)  
COLOR MAY NOT BE EXACTLY SHOWN

## Supermarket shelves & supermarket accessories

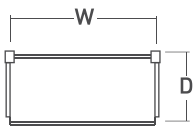

**SP - 210**  
924W x 460D x 1489H mm.

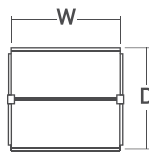

**SP - 220**  
924W x 851D x 1489H mm.

**SP - 20**  
899W x 403D x 29H mm.

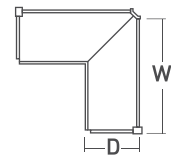

**SP - 310 B**  
1384W x 460D x 1489H mm.

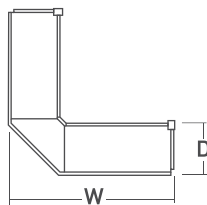
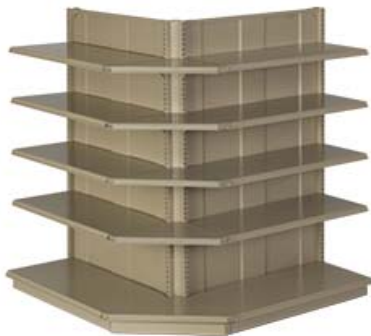

**SP - 310 F**  
1384W x 460D x 1489H mm.

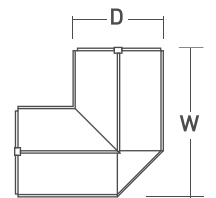

**SP - 320**  
1384W x 851D x 1489H mm.

**SP - 30**  
584W x 289D x 29H mm.

**BODY COLOR : CREAM (#180)**  
COLOR MAY NOT BE EXACTLY SHOWN



## Multi - purpose shelves



**SGH - 1634**  
880W x 405D x 1739H mm.



**SGH - 1835**  
900W x 450D x 1830H mm.



**SG - 1634**  
880W x 405D x 877H mm.



**SG - 1835**  
900W x 450D x 922H mm.

 **BODY COLOR : CREAM (#180)**  
COLOR MAY NOT BE EXACTLY SHOWN

## Storage shelves



**S - 2136 N**  
914W x 457D x 1830H mm.



**S - 2133 N**  
914W x 457D x 930H mm.



**S - 2436 N**  
914W x 610D x 1830H mm.



**S - 2434 N**  
914W x 610D x 1230H mm.

## Shelves for storage shelves



**S - 21 N**  
914W x 457D x 35H mm.



**S - 24 N**  
914W x 610D x 35H mm.

 **BODY COLOR : CREAM (#180)**  
COLOR MAY NOT BE EXACTLY SHOWN

 **BODY COLOR : DEEP GRAY (#170)**  
COLOR MAY NOT BE EXACTLY SHOWN

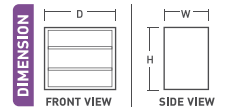

# INDUSTRIAL SHELVES

## Light - weight



**IES - 01**  
1200W x 603D x 1829H mm.

**IES - 011**  
1800W x 603D x 1829H mm.

 BODY COLOR : DEEP GRAY (#170)  
COLOR MAY NOT BE EXACTLY SHOWN



**IES - 02**  
1200W x 603D x 1240H mm.

**IES - 021**  
1800W x 603D x 1240H mm.

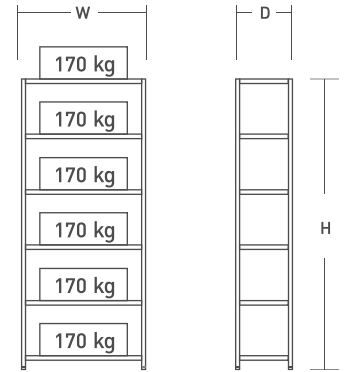

**IES - 01, 02**

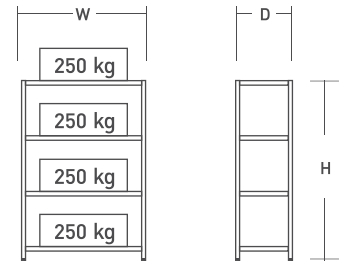

**IES - 011, 021**

## Heavy - duty

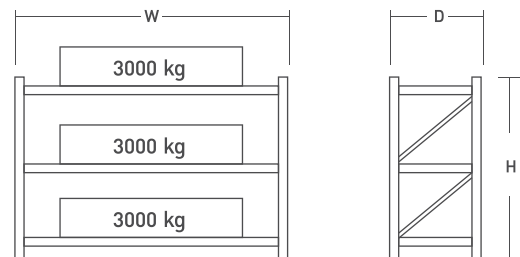

**IES - 60240**  
2646W x 610D x 2400H mm.

**IES - 90240**  
2646W x 910D x 2400H mm.

 BODY COLOR : DEEP GRAY (#170)  
COLOR MAY NOT BE EXACTLY SHOWN

# OA SHELVES

## Type 6S light - duty shelving

Easy to assemble, easy to move and ideal for small to medium - item storage.

TYPE 6S is economical and ideal for small to medium-weight items. one unit withstands loads up to 1500 kg. Our original boltless structure enables an easy installation. Extra Shelves can be added easily to create a "Custom" display. the addition of TYPE 6S shelf requires only one upright at the front and back, saving space and cost.



Uprights are connected to each other by connectors and securely tightened with special fasteners.



Shelves can be easily installed on brackets and are adjustable at a 25 mm. pitch to match various sizes of items. Assembly involves only inserting the brackets into slits on the upright.



Resin base plates do not leave scratch marks on a floor.

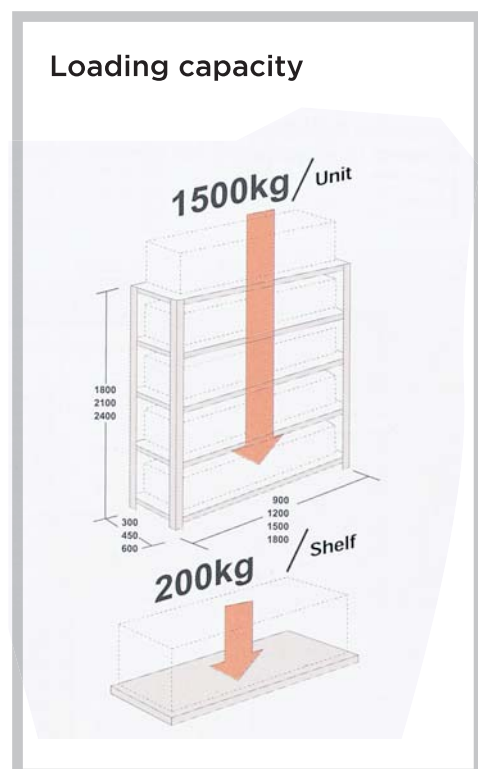



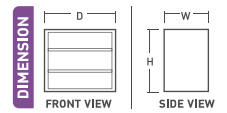

# OA SHELVES

## Type 6S light - duty shelves

HEIGHT		1800 H			
<p><b>Shelves</b></p> <p><b>COLOR SPEC : Z273</b></p>		<p><b>4 - Shelves</b></p>		<p><b>5 - Shelves</b></p>	
CORD		Independent	Connectable	Independent	Connectable
900 W	300 D	6S 64 AA	6S 64 BA	6S 65 AA	6S 65 BA
940 (W1)	450 D	6S 64 AB	6S 64 BB	6S 65 AB	6S 65 BB
900 (W2)	600 D	6S 64 AC	6S 64 BC	6S 65 AC	6S 65 BC
1200 W	300 D	6S 64 AD	6S 64 BD	6S 65 AD	6S 65 BD
1240 (W1)	450 D	6S 64 AE	6S 64 BE	6S 65 AE	6S 65 BE
1200 (W2)	600 D	6S 64 AF	6S 64 BF	6S 65 AF	6S 65 BF
1500 W	300 D	6S 64 AG	6S 64 BG	6S 65 AG	6S 65 BG
1540 (W1)	450 D	6S 64 AH	6S 64 BH	6S 65 AH	6S 65 BH
1500 (W2)	600 D	6S 64 AI	6S 64 BI	6S 65 AI	6S 65 BI
1800 W	300 D	6S 64 AJ	6S 64 BJ	6S 65 AJ	6S 65 BJ
1840 (W1)	450 D	6S 64 AK	6S 64 BK	6S 65 AK	6S 65 BK
1800 (W2)	600 D	6S 64 AL	6S 64 BL	6S 65 AL	6S 65 BL

HEIGHT		2100 H					
<p><b>Shelves</b></p> <p><b>COLOR SPEC : Z273</b></p>		<p><b>4 - Shelves</b></p>		<p><b>5 - Shelves</b></p>		<p><b>6 - Shelves</b></p>	
CORD		Independent	Connectable	Independent	Connectable	Independent	Connectable
900 W	300 D	6S 74 AA	6S 74 BA	6S 75 AA	6S 75 BA	6S 76 AA	6S 76 BA
940 (W1)	450 D	6S 74 AB	6S 74 BB	6S 75 AB	6S 75 BB	6S 76 AB	6S 76 BB
900 (W2)	600 D	6S 74 AC	6S 74 BC	6S 75 AC	6S 75 BC	6S 76 AC	6S 76 BC
1200 W	300 D	6S 74 AD	6S 74 BD	6S 75 AD	6S 75 BD	6S 76 AD	6S 76 BD
1240 (W1)	450 D	6S 74 AE	6S 74 BE	6S 75 AE	6S 75 BE	6S 76 AE	6S 76 BE
1200 (W2)	600 D	6S 74 AF	6S 74 BF	6S 75 AF	6S 75 BF	6S 76 AF	6S 76 BF
1500 W	300 D	6S 74 AG	6S 74 BG	6S 75 AG	6S 75 BG	6S 76 AG	6S 76 BG
1540 (W1)	450 D	6S 74 AH	6S 74 BH	6S 75 AH	6S 75 BH	6S 76 AH	6S 76 BH
1500 (W2)	600 D	6S 74 AI	6S 74 BI	6S 75 AI	6S 75 BI	6S 76 AI	6S 76 BI
1800 W	300 D	6S 74 AJ	6S 74 BJ	6S 75 AJ	6S 75 BJ	6S 76 AJ	6S 76 BJ
1840 (W1)	450 D	6S 74 AK	6S 74 BK	6S 75 AK	6S 75 BK	6S 76 AK	6S 76 BK
1800 (W2)	600 D	6S 74 AL	6S 74 BL	6S 75 AL	6S 75 BL	6S 76 AL	6S 76 BL

## Type 6S light - duty shelves

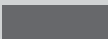
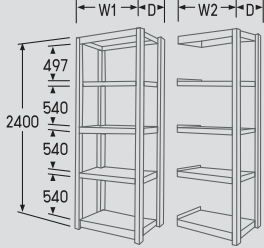
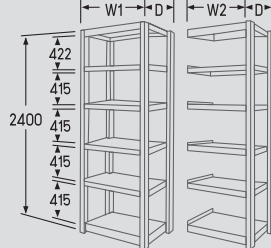
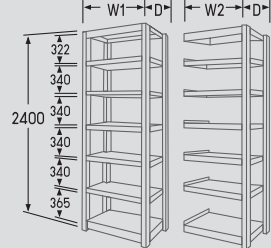
HEIGHT		2400 H					
<b>Shelves</b>    <b>COLOR SPEC : Z269</b>		<b>5 - Shelves</b> 		<b>6 - Shelves</b> 		<b>7 - Shelves</b> 	
		<b>CORD</b>		<b>Independent</b>	<b>Connectable</b>	<b>Independent</b>	<b>Connectable</b>
900 W	300 D	6S 85 AA	6S 85 BA	6S 86 AA	6S 86 BA	6S 87 AA	6S 87 BA
940 (W1)	450 D	6S 85 AB	6S 85 BB	6S 86 AB	6S 86 BB	6S 87 AB	6S 87 BB
900 (W2)	600 D	6S 85 AC	6S 85 BC	6S 86 AC	6S 86 BC	6S 87 AC	6S 87 BC
1200 W	300 D	6S 85 AD	6S 85 BD	6S 86 AD	6S 86 BD	6S 87 AD	6S 87 BD
1240 (W1)	450 D	6S 85 AE	6S 85 BE	6S 86 AE	6S 86 BE	6S 87 AE	6S 87 BE
1200 (W2)	600 D	6S 85 AF	6S 85 BF	6S 86 AF	6S 86 BF	6S 87 AF	6S 87 BF
1500 W	300 D	6S 85 AG	6S 85 BG	6S 86 AG	6S 86 BG	6S 87 AG	6S 87 BG
1540 (W1)	450 D	6S 85 AH	6S 85 BH	6S 86 AH	6S 86 BH	6S 87 AH	6S 87 BH
1500 (W2)	600 D	6S 85 AI	6S 85 BI	6S 86 AI	6S 86 BI	6S 87 AI	6S 87 BI
1800 W	300 D	6S 85 AJ	6S 85 BJ	6S 86 AJ	6S 86 BJ	6S 87 AJ	6S 87 BJ
1840 (W1)	450 D	6S 85 AK	6S 85 BK	6S 86 AK	6S 86 BK	6S 87 AK	6S 87 BK
1800 (W2)	600 D	6S 85 AL	6S 85 BL	6S 86 AL	6S 86 BL	6S 87 AL	6S 87 BL



TYPE A ( Open Type )



TYPE B ( Box Type )  
Special Order



TYPE C ( Mesh Panel Type )  
Special Order

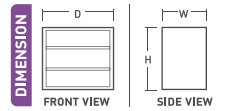

# OA SHELVES

## TYPE R46 MEDIUM DUTY SHELVING

Excellent load capacity for efficient storage of different size and shape medium - weight merchandize

This all - purpose medium - duty shelf features the flexibility to accommodate merchandize in different sizes and shapes and the dependability of a 2,000 kg. loading capacity. The boltless construction makes the shelf to be assembled and to be adjusted to match either an increase or decrease in inventory.



**Strong and rigid shelves**

### Structure

Extra shelves can be added easily to create a "custom" display. The addition of a TYPE R46 Shelf requires of only one upright at the front and back, saving space and cost. Shelves can be moved by simple repositioning the brackets. Hooks on the brackets are engaged at four points for all around support and rigidity.

**TYPE A (Open Type)**

**TYPE B (Box Type)**  
*Special Order*



### Loading capacity

Unit loading capacity

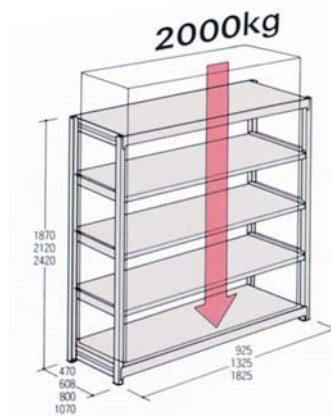

Capacity shelf

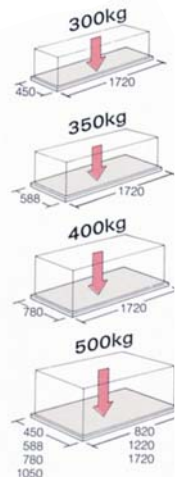

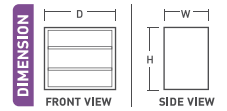

# Type R46 shelves

	900 W		1300 W		1800 W	
	Independent	Connectable	Independent	Connectable	Independent	Connectable
<b>1870 H</b>						
Depth						
470 D	6Y65AA-Z-40	6Y65BA-Z-40	6Y65AL-Z-40	6Y65BL-Z-40	6Y65AO-Z-40	6Y65BO-Z-40
608 D	6Y65AB-Z-40	6Y65BB-Z-40	6Y65AM-Z-40	6Y65BM-Z-40	6Y65AP-Z-40	6Y65BP-Z-40
800 D	6Y65AC-Z-40	6Y65BC-Z-40			6Y65AQ-Z-40	6Y65BQ-Z-40
1070 D	6Y65AD-Z-40	6Y65BD-Z-40			6Y65AR-Z-40	6Y65BR-Z-40
<b>1870 H</b>						
Depth						
470 D	6Y66AA-Z-40	6Y66BA-Z-40	6Y66AL-Z-40	6Y66BL-Z-40	6Y66AO-Z-40	6Y66BO-Z-40
608 D	6Y66AB-Z-40	6Y66BB-Z-40	6Y66AM-Z-40	6Y66BM-Z-40	6Y66AP-Z-40	6Y66BP-Z-40
800 D	6Y66AC-Z-40	6Y66BC-Z-40			6Y66AQ-Z-40	6Y66BQ-Z-40
1070 D	6Y66AD-Z-40	6Y66BD-Z-40			6Y66AR-Z-40	6Y66BR-Z-40
<b>2120 H</b>						
Depth						
470 D	6Y75AA-Z-40	6Y75BA-Z-40	6Y75AL-Z-40	6Y75BL-Z-40	6Y75AO-Z-40	6Y75BO-Z-40
608 D	6Y75AB-Z-40	6Y75BB-Z-40	6Y75AM-Z-40	6Y75BM-Z-40	6Y75AP-Z-40	6Y75BP-Z-40
800 D	6Y75AC-Z-40	6Y75BC-Z-40			6Y75AQ-Z-40	6Y75BQ-Z-40
1070 D	6Y75AD-Z-40	6Y75BD-Z-40			6Y75AR-Z-40	6Y75BR-Z-40
<b>2120 H</b>						
Depth						
470 D	6Y76AA-Z-40	6Y76BA-Z-40	6Y76AL-Z-40	6Y76BL-Z-40	6Y76AO-Z-40	6Y76BO-Z-40
608 D	6Y76AB-Z-40	6Y76BB-Z-40	6Y76AM-Z-40	6Y76BM-Z-40	6Y76AP-Z-40	6Y76BP-Z-40
800 D	6Y76AC-Z-40	6Y76BC-Z-40			6Y76AQ-Z-40	6Y76BQ-Z-40
1070 D	6Y76AD-Z-40	6Y76BD-Z-40			6Y76AR-Z-40	6Y76BR-Z-40
<b>2420 H</b>						
Depth						
470 D	6Y85AA-Z-40	6Y85BA-Z-40	6Y85AL-Z-40	6Y85BL-Z-40	6Y85AO-Z-40	6Y85BO-Z-40
608 D	6Y85AB-Z-40	6Y85BB-Z-40	6Y85AM-Z-40	6Y85BM-Z-40	6Y85AP-Z-40	6Y85BP-Z-40
800 D	6Y85AC-Z-40	6Y85BC-Z-40			6Y85AQ-Z-40	6Y85BQ-Z-40
1070 D	6Y85AD-Z-40	6Y85BD-Z-40			6Y85AR-Z-40	6Y85BR-Z-40
<b>2420 H</b>						
Depth						
470 D	6Y86AA-Z-40	6Y86BA-Z-40	6Y86AL-Z-40	6Y86BL-Z-40	6Y86AO-Z-40	6Y86BO-Z-40
608 D	6Y86AB-Z-40	6Y86BB-Z-40	6Y86AM-Z-40	6Y86BM-Z-40	6Y86AP-Z-40	6Y86BP-Z-40
800 D	6Y86AC-Z-40	6Y86BC-Z-40			6Y86AQ-Z-40	6Y86BQ-Z-40
1070 D	6Y86AD-Z-40	6Y86BD-Z-40			6Y86AR-Z-40	6Y86BR-Z-40

# OTHERS

Furniture accessories & special products are designed to support various functions both at office and home to have more perfection and efficiency, namely document tray, filing box and stand, mobile folding stage, mobile stand for visualizer & overhead projector and mobile white board & hanging white board, etc.

---

ชุดเฟอร์นิเจอร์ที่เป็นอุปกรณ์เสริมและสนับสนุน ช่วยให้การใช้งาน Function ต่างๆ ทั้งในสำนักงานและบ้านพักอาศัยครบถ้วนและมีประสิทธิภาพยิ่งขึ้น เช่น ถาดใส่เอกสาร กล่องแฟ้ม ขาตั้งกล่องแฟ้ม ชุดเวทีพับเคลื่อนที่ โต๊ะวางเครื่องฉายสไลด์และ Overhead Projector เคลื่อนที่ กระดานเคลื่อนที่ และติดผนัง เป็นต้น



# MODERN HOME AND HOME OFFICE

## Multipurpose bed



**BD - BN17**  
2055W x 970D x 2000H mm.



**BD - AN17**  
2055W x 970D x 2000H mm.



**BD - 2N17**  
2055W x 980D x 2230H mm.



**BD - CN17**  
2055W x 970D x 2000H mm.



**BS - 36**  
1130W x 2060D x 605H mm.



## Audio / VDO cabinets



**VDO - 171**  
509W x 470D x 594H mm.

**BODY COLOR : CREAM (#180)**  
COLOR MAY NOT BE EXACTLY SHOWN



**VDO - 172**  
509W x 470D x 690H mm.

**WORK TOP COLOR : HIGH PRESSURE LAMINATE (PP 7010 UN)**  
COLOR MAY NOT BE EXACTLY SHOWN

**BODY COLOR : CREAM (#180)**  
COLOR MAY NOT BE EXACTLY SHOWN

## Wardrobes



**HF - 222**  
366W x 558D x 660H mm.  
*(FOR US LETTER & FOOLSCAP)*

**BODY COLOR : CREAM (#180)**  
COLOR MAY NOT BE EXACTLY SHOWN



**LMC - 606**  
600W x 600D x 1900H mm.

**BODY COLOR : PUTTY (#143)**  
COLOR MAY NOT BE EXACTLY SHOWN

## KITCHEN SETS



**LMH - 60**  
600W x 400D x 700H mm.

**BODY COLOR : LIGHT CREAM (#260)**  
COLOR MAY NOT BE EXACTLY SHOWN



**LMW - 105**  
1050W x 490D x 800H mm.

**WORK TOP : POSTFORM MELAMINE LAMINATE**  
NO.PF 6149 IM (#260)

**BODY COLOR : LIGHT CREAM (#260)**  
COLOR MAY NOT BE EXACTLY SHOWN



**LMS - 105**  
1050W x 490D x 800H mm.

# SPECIAL PRODUCT & FURNITURE ACCESSORIES

## Folding / Mobile stages



**FT - 1224**

2440W x 1220D x ( 200-1200H ) mm.  
ADJUST 3 STEP 800,1000,1200(H) mm.



**FMS - 468**

2450W x 2450D x ( 400-800H ) mm.  
ADJUST 3 STEP 400,600,800(H) mm.

**FMS - 6810**

2450W x 2450D x ( 600-1000H ) mm.  
ADJUST 3 STEP 800,1000,1200(H) mm.

## Portable step units



**LAD - 3**

775W x 650D x 1400H mm.



**LAD - 2**

740W x 780D x 490H mm.



**LAD - 360**

750W x 900D x 600H mm.

## Newspaper & Magazine racks



**NMG - 3016**

715W x 410D x 935H mm.



**NMG - 3017**

720W x 405D x 950H mm.



**NMG - 3018**

720W x 438D x 950H mm.

## White boards hanging type & Standing type



**BW - 6090**  
900W x 75D x 600H mm.



**BW - 90150 N**  
1577W x 80D x 1040H mm.



**BS - 90150 N**  
1580W x 580D x 1730H mm.

**BW - 90120**  
1200W x 75D x 900H mm.

**BW - 90180 N**  
1877W x 80D x 1040H mm.

**BS - 90180 N**  
1880W x 580D x 1730H mm.

## Key boxes



**KB - 10 - 20V**  
250W x 50D x 300H mm.



**KB - 830**  
405W x 80D x 375H mm.

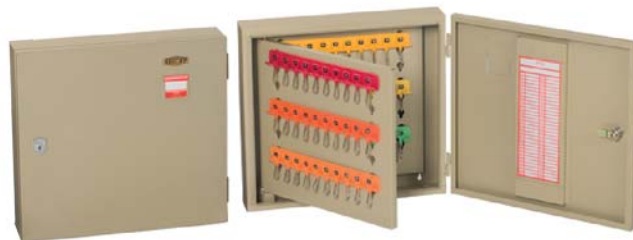

**KB - 860**  
405W x 80D x 375H mm.



**KB - 8100**  
530W x 110D x 550H mm.



**KB - 8200**  
530W x 110D x 550H mm.

**BODY COLOR : CREAM (#180)**  
COLOR MAY NOT BE EXACTLY SHOWN

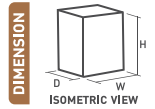

## Document trays



**F - 3042**  
238W x 360D x 95H mm.



**F - 3043**  
238W x 360D x 140H mm.



**BODY COLOR : CREAM (#180)**  
COLOR MAY NOT BE EXACTLY SHOWN

## Stands & Mobile stands



**SK - 1216**  
305W x 405D x 680H mm.

**SK - 1616**  
405W x 405D x 680H mm.

**SK - 1624**  
405W x 610D x 680H mm.



**SN - 3040**  
406W x 306D x 632H mm.

**SN - 4040**  
406W x 406D x 632H mm.

**SN - 4060**  
609W x 406D x 632H mm.



**S - 851**  
275W x 616D x 590H mm.



**BODY COLOR : CREAM (#180)**  
COLOR MAY NOT BE EXACTLY SHOWN



**DARK GRAY (#170)**  
COLOR MAY NOT BE EXACTLY SHOWN  
(OPTIONAL)

## Podiums



**PDM - 001**  
795W x 670D x 1055H mm.

## Card boxes



**S- 250**  
124W x 42D x 94H mm.



**BODY COLOR : CREAM (#180)**  
COLOR MAY NOT BE EXACTLY SHOWN

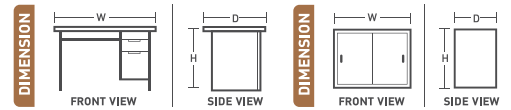

# INDUSTRIAL EQUIPMENTS

## Work benches



**IET - 30**  
1800W x 750D x 750H mm.



**IET - 40**  
1800W x 750D x 1105H mm.



**H - 70**  
1800W x 20D x 900H mm.



**IET - 70 - 1D**  
1800W x 700D x 750H mm.



**IET - 70 - 2D**  
1800W x 700D x 750H mm.



**IET - 70 - 1D + H - 70**

## Tooling storage cabinets



**IEL - 9110**  
900W x 450D x 1100H mm.



**IEL - 9185**  
900W x 450D x 1850H mm.



**IEL - 02**  
600W x 460D x 815H mm.



**IEL - 11**  
800W x 600D x 1100H mm.

**IEL - 02S**  
600W x 460D x 815H mm.



BODY COLOR : CREAM (#180)  
COLOR MAY NOT BE EXACTLY SHOWN

OTHERS

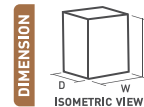

## Hardware cabinets



**SWC - 40**

580W x 590D x 880H mm.

**SWC - 32**

580W x 590D x 880H mm.

**SWC - 24**

580W x 590D x 880H mm.

**SWC - 16**

580W x 590D x 880H mm.

**SWC - 08**

580W x 590D x 880H mm.



**IEB - 9185**

900W x 450D x 1850H mm.



BODY COLOR : CREAM (#180)  
COLOR MAY NOT BE EXACTLY SHOWN

## Carts



**IEC - 10**

600W x 900D x 845H mm.



**IEC - 20**

700W x 1000D x 985H mm.



LIGHT GRAY (#150)  
(OPTIONAL)

## Mobile stands



**IEC - 4060**

600W x 400D x 750H mm.



**IEC - 4060 B**

600W x 400D x 750H mm.



**IEC - 4060 H**

600W x 400D x 750H mm.



BODY COLOR : CREAM (#180)  
COLOR MAY NOT BE EXACTLY SHOWN



# PROJECT REFERENCES



THE GOVERNMENT COMPLEX COMMEMORATING HIS MAJESTY THE KING'S 80<sup>th</sup> BIRTHDAY ANNIVERSARY, 5<sup>th</sup> DECEMBER, B.E.2550 (2007) ; CONFERENCE ROOM



ARMY MEDICAL DEPARTMENT SCHOOL ; OFFICE, MINISTRY OF DEFENCE

# PROJECT REFERENCES



ARMY MEDICAL DEPARTMENT SCHOOL ; LOCKERS, MINISTRY OF DEFENCE



SOCIAL SECURITY OFFICE AREA 8 ; SERVICE AREA, MINISTRY OF FINANCE





MINISTRY OF CULTURE ; CONFERENCE ROOM

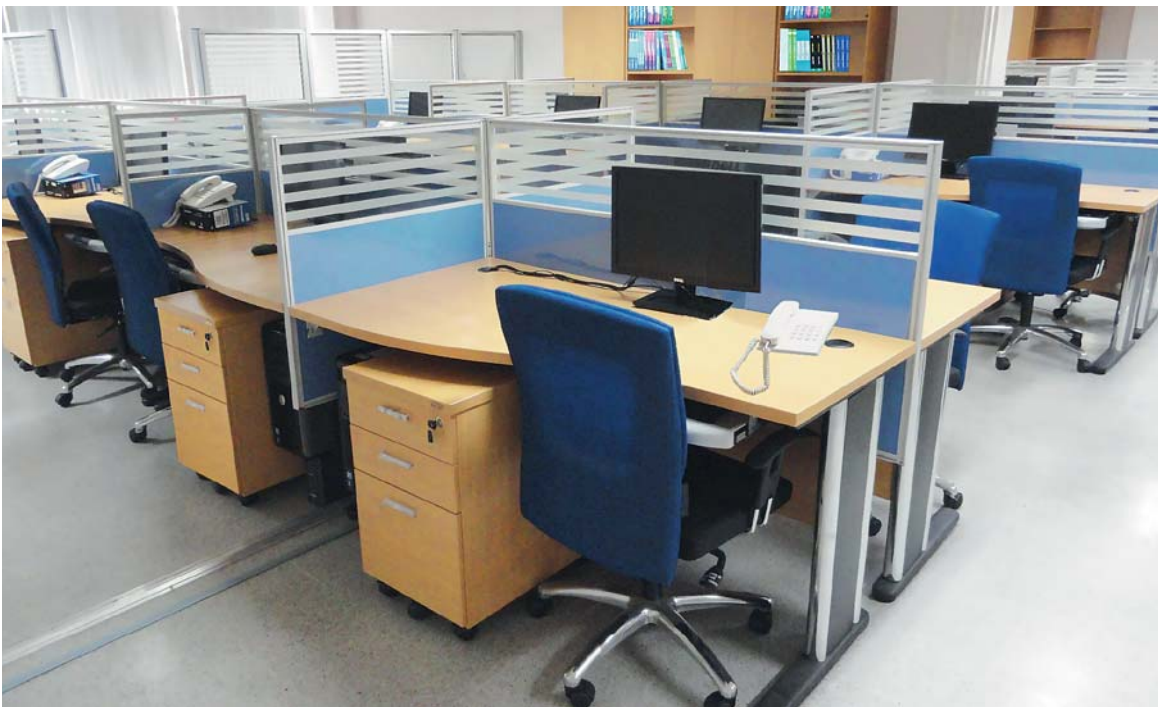

MINISTRY OF LABOUR ; WORKING ROOM

# PROJECT REFERENCES



มหาวิทยาลัยขอนแก่น (KHON KHAEN UNIVERSITY)  
เก้าอี้รุ่น CL - 920S ภายในศูนย์ประชุมอเนกประสงค์กาญจนาภิเษก



มหาวิทยาลัยสารคาม (MAHASARAKHAM UNIVERSITY)  
เก้าอี้รุ่น CL - 915L ภายในหอประชุมอเนกประสงค์





กระทรวงมหาดไทย (MINISTRY OF INTERIOR)  
เก้าอี้รุ่น ADT - 250EXL ในห้องประชุมของกรมการปกครอง



มหาวิทยาลัยราชภัฏพระนคร (PHRANAKHON RAJABHAT UNIVERSITY)

# PROJECT REFERENCES



มหาวิทยาลัยแม่ฟ้าหลวง (MAE FAH LUANG UNIVERSITY)  
เก้าอี้รุ่น CL - 940L ภายในห้องประชุมใหญ่มหาวิทยาลัยแม่ฟ้าหลวง

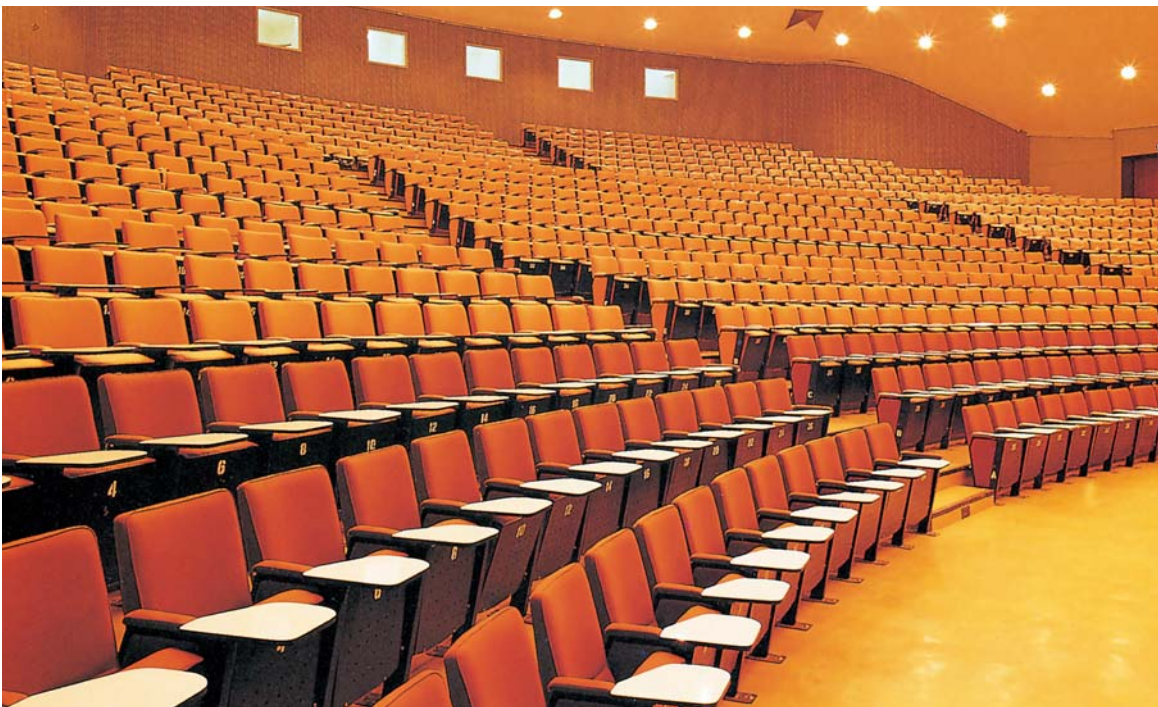

มหาวิทยาลัยธรรมศาสตร์ (THAMMASART UNIVERSITY)  
เก้าอี้รุ่น CL - 920L ภายในหอประชุมเอนกประสงค์





มหาวิทยาลัยเทคโนโลยีสุรนารี (SURANAREE UNIVERSITY OF TECHNOLOGY)  
เก้าอี้รุ่น CL - 920L ภายในห้องประชุมใหญ่



CENTRA GOVERNMENT COMPLEX HOTEL & CONVENTION CENTRE CHAENG WATTHANA

# PROJECT REFERENCES



SPORT AUTHORITY OF THAILAND ; STADIUM SEATINGS MINISTRY OF TOURISM & SPORTS



CHIANG MAI INTERNATIONAL AIRPORT ; RENOVATION





### 13<sup>th</sup> ASIAN GAMES

คณะกรรมการจัดการแข่งขันกีฬาเอเชียนเกมส์ได้มอบหมายให้บริษัทฯ ติดตั้งเก้าอี้สำหรับผู้ชมการแข่งขันกีฬาเอเชียนเกมส์ครั้งที่ 13 ภายในศูนย์กีฬามหาวิทยาลัยธรรมศาสตร์รังสิต อาทิ Main Stadium ที่ได้รับการออกแบบให้ทันสมัย (แบบเดียวกับสนามกีฬาในประเทศออสเตรเลียที่แข่งขันกีฬาโอลิมปิกปี 2000) จึงได้ติดตั้งเก้าอี้รุ่นพิเศษที่มีคุณสมบัติแข็งแรงทนทาน จำนวน 20,000 ที่นั่ง และ Aquatic Center สระว่ายน้ำขนาดมาตรฐานโอลิมปิกได้หลังคาแห่งแรกของเมืองไทย เป็นจำนวน 5,000 ที่นั่ง



### กระทรวงมหาดไทย (MINISTRY OF INTERIOR)

เก้าอี้รุ่น CM - 001 ในห้องประชุมของศูนย์บริการกิจการอิสลาม

# PROJECT REFERENCES



จุฬาลงกรณ์มหาวิทยาลัย (CHULALONGKORN UNIVERSITY)

เก้าอี้รุ่น CL - 920L ภายในห้องประชุมคณะเภสัชศาสตร์

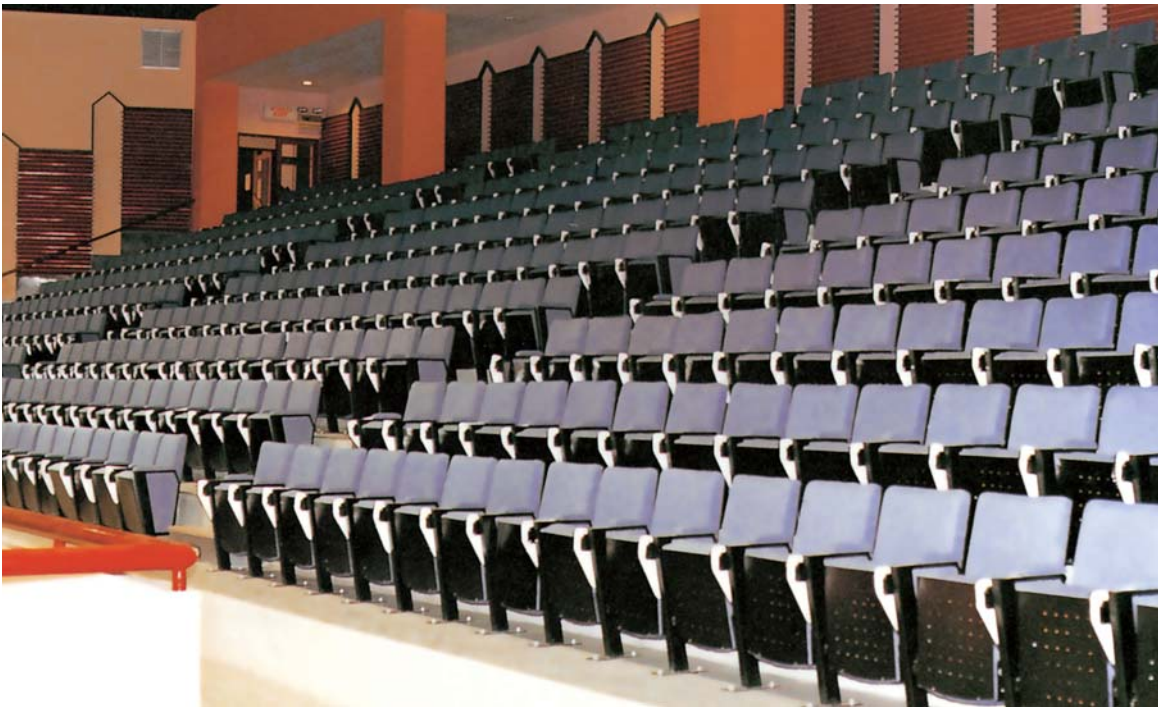

มหาวิทยาลัยเชียงใหม่ (CHIANG MAI UNIVERSITY)

เก้าอี้รุ่น CL - 920L ภายในหอประชุมมหาวิทยาลัยเชียงใหม่





THE GOVERNMENT COMPLEX COMMEMORATING HIS MAJESTY THE KING'S 80<sup>th</sup> BIRTHDAY ANNIVERSARY, 5<sup>th</sup> DECEMBER, B.E.2550 (2007) ; AUDITORIUM SEATINGS



กระทรวงมหาดไทย (MINISTRY OF INTERIOR)  
ตู้เอกสารแบบรางเลื่อน IEM 200 ในกรมการปกครอง





Contact our agent



**SIAM STEEL INTERNATIONAL** PUBLIC COMPANY LIMITED

51 MOO 2, POOCHAO ROAD, BANGYAPRAK,  
PHRAPRADAENG, SAMUTPRAKARN 10130, THAILAND.

TEL : +66 (0) 2384 - 2876, 2348 - 3000, 2348 - 3030

FAX : +66 (0) 2384 - 2330, 2394 - 2873

<http://www.siamsteel.com>

e-mail : [center@siamsteel.com](mailto:center@siamsteel.com)